

GPSMAP® 695/696

Portable Aviation Receiver
Owner's Manual



GARMIN ▲

OVERVIEW

GPS NAVIGATION

FLIGHT PLANNING

HAZARD AVOIDANCE

ADDITIONAL FEATURES

APPENDICES

INDEX

Copyright © 2008, 2012 Garmin Ltd. or its subsidiaries. All rights reserved.

This manual reflects the operation of System Software version 6.20 or later. Some differences in operation may be observed when comparing the information in this manual to earlier or later software versions.

Garmin International, Inc., 1200 East 151st Street, Olathe, Kansas 66062, U.S.A.
Tel: 913/397.8200 Fax: 913/397.8282

Garmin AT, Inc., 2345 Turner Road SE, Salem, OR 97302, U.S.A.
Tel: 503/391.3411 Fax 503/364.2138

Garmin (Europe) Ltd, Liberty House, Bulls Copse Road, Hounslow Business Park,
Southampton, SO40 9RB, U.K.
Tel: 44/0870.8501241 Fax: 44/0870.8501251

Garmin Corporation, No. 68, Jangshu 2nd Road, Shijr, Taipei County, Taiwan
Tel: 886/02.2642.9199 Fax: 886/02.2642.9099

Web Site Address: www.garmin.com

Except as expressly provided herein, no part of this manual may be reproduced, copied, transmitted, disseminated, downloaded or stored in any storage medium, for any purpose without the express written permission of Garmin. Garmin hereby grants permission to download a single copy of this manual and of any revision to this manual onto a hard drive or other electronic storage medium to be viewed for personal use, provided that such electronic or printed copy of this manual or revision must contain the complete text of this copyright notice and provided further that any unauthorized commercial distribution of this manual or any revision hereto is strictly prohibited.

Garmin®, GPSMAP®, FliteCharts® and SafeTaxi® are registered trademarks of Garmin Ltd. or its subsidiaries. These trademarks may not be used without the express permission of Garmin.

Jeppesen® is a registered trademark of Jeppesen, Inc.

NavData® is a registered trademark of Jeppesen, Inc.

AC-U-KWIK® is a registered trademark of Penton Business Media, Inc.

SiriusXM Satellite Radio is provided by SiriusXM Satellite Radio, Inc.

SiriusXM Weather is provided by SiriusXM Satellite Radio, Inc.





WARNING: When installing the GPSMAP® 695/696, place the unit so it does not obstruct the field of view or interfere with operating controls.



WARNING: The indicators represented on the Panel are based on GPS-derived data and may differ from the instruments in the aircraft.



WARNING: The GPSMAP 695/696 is intended only as an aid for VFR navigation. Do not attempt to use this unit for any purpose requiring precise measurement of direction, distance, location, or topography.



WARNING: Navigation and terrain separation must NOT be predicated upon the use of the terrain function. The GPSMAP 695/696 Terrain Proximity feature is NOT intended to be used as a primary reference for terrain avoidance and does not relieve the pilot from the responsibility of being aware of surroundings during flight. The Terrain Proximity feature is only to be used as an aid for terrain avoidance and is not certified for use in applications requiring a certified terrain awareness system. Terrain data is obtained from third party sources. Garmin is not able to independently verify the accuracy of the terrain data.



WARNING: The displayed minimum safe altitudes (MSAs) are only advisory in nature and should not be relied upon as the sole source of obstacle and terrain avoidance information. Always refer to current aeronautical charts for appropriate minimum clearance altitudes.



WARNING: The altitude calculated by GPSMAP 695/696 GPS receiver is geometric height above Mean Sea Level and could vary significantly from the altitude displayed by pressure altimeters. GPS altitude should never be used for vertical navigation.



WARNING: Do not use outdated database information. Databases used in the GPSMAP 695/696 must be updated regularly in order to ensure that the information remains current. Pilots using any outdated database do so entirely at their own risk.



WARNING: Do not use basemap (land and water data) information for primary navigation. Basemap data is intended only to supplement other approved navigation data sources and should be considered as an aid to enhance situational awareness.



WARNING: Do not rely solely upon the display of traffic information for collision avoidance maneuvering. The traffic display does not provide collision avoidance resolution advisories and does not under any circumstances or conditions relieve the pilot's responsibility to see and avoid other aircraft.



WARNING: Do not rely solely upon the display of traffic information to accurately depict all of the traffic within range of the aircraft. Due to lack of equipment, poor signal reception, and/or inaccurate information from aircraft or ground stations, traffic may be present that is not represented on the display.



WARNING: Do not use data link weather information for maneuvering in, near, or around areas of hazardous weather. Information contained with in data link weather products may not accurately depict current weather conditions.



WARNING: Do not use the indicated data link weather product age to determine the age of the weather information shown by the data link weather product. Due to time delays inherent in gathering and processing weather data for data link transmission, the weather information shown by the data link weather product may be significantly older than the indicated weather product age.



WARNING: For safety reasons, GPSMAP 695/696 operational procedures must be learned on the ground.



WARNING: The United States government operates the Global Positioning System and is solely responsible for its accuracy and maintenance. The GPS system is subject to changes which could affect the accuracy and performance of all GPS equipment. Portions of the Garmin GPSMAP 695/696 utilize GPS as a precision electronic NAVigation AID (NAVAID). Therefore, as with all NAVAIDs, information presented by the GPSMAP 695/696 can be misused or misinterpreted and, therefore, become unsafe.



WARNING: To reduce the risk of unsafe operation, carefully review and understand all aspects of the GPSMAP 695/696 User's Manual documentation and the Pilot's Operating Handbook for the aircraft. Thoroughly practice basic operation prior to actual use. During flight operations, carefully compare indications from the GPSMAP 695/696 to all available navigation sources, including the information from other NAVAIDs, visual sightings, charts, etc. For safety purposes, always resolve any discrepancies before continuing navigation.



WARNING: The illustrations in this guide are only examples. Never use the GPSMAP 695/696 to attempt to penetrate a thunderstorm. Both the FAA Advisory Circular, Subject: Thunderstorms, and the Aeronautical Information Manual (AIM) recommend avoiding "by at least 20 miles any thunderstorm identified as severe or giving an intense radar echo."



CAUTION: The display uses a lens coated with a special anti-reflective coating that is very sensitive to skin oils, waxes, and abrasive cleaners. **CLEANERS CONTAINING AMMONIA WILL HARM THE ANTI-REFLECTIVE COATING.** It is very important to clean the lens using a clean, lint-free cloth and an eyeglass lens cleaner that is specified as safe for anti-reflective coatings.



CAUTION: The Garmin GPSMAP 695/696 does not contain any user-serviceable parts. Repairs should only be made by an authorized Garmin service center. Unauthorized repairs or modifications could void both the warranty and the pilot's authority to operate this device under FAA/FCC regulations.



NOTE: The Garmin GPSMAP 695/696 has a very high degree of functional integrity. However, the pilot must recognize that providing monitoring and/or self-test capability for all conceivable system failures is not practical. Although unlikely, it may be possible for erroneous operation to occur without a fault indication shown by the GPSMAP 695/696. It is thus the responsibility of the pilot to detect such an occurrence by means of cross-checking with all redundant or correlated information available in the cockpit.



NOTE: All visual depictions contained within this document, including screen images of the GPSMAP 695/696 display, are subject to change and may not reflect the most current GPSMAP 695/696 and aviation databases. Depictions of equipment may differ slightly from the actual equipment.



NOTE: This device complies with part 15 of the FCC Rules. Operation is subject to the following two conditions: (1) this device may not cause harmful interference, and (2) this device must accept any interference received, including interference that may cause undesired operation.



NOTE: The data contained in the terrain and obstacle databases comes from government agencies. Garmin accurately processes and cross-validates the data, but does not guarantee the accuracy and completeness of the data.



NOTE: This product, its packaging, and its components contain chemicals known to the State of California to cause cancer, birth defects, or reproductive harm. This notice is being provided in accordance with California's Proposition 65. If you have any questions or would like additional information, please refer to our web site at www.garmin.com/prop65.



NOTE: Use of polarized eyewear may cause the display to appear dim or blank.



NOTE: Do not rely solely upon data link services to provide Temporary Flight Restriction TFR information. Always confirm TFR information through official sources such as Flight Service Stations of Air Traffic Control.



NOTE: SiriusXM Weather is only available when the optional GXM 40 antenna is installed.

Part Number	Change Summary
190-00919-00	Initial release.

Rev	Date	Description
D	November, 2008	Production Release.
E	March, 2012	<p>System Software Version 2.00 - 2.20 changes:</p> <ul style="list-style-type: none"> Added separate leg and cumulative distance, ETE, and fuel fields to the flight plan pages. <p>System Software Version 2.20-2.30 changes:</p> <ul style="list-style-type: none"> Added indication of airport CTAF frequencies to WPT page. <p>System Software Version 2.70-2.80 changes:</p> <ul style="list-style-type: none"> Added display of plain-language PIREP text. Added display of VOR radials when airway is highlighted. Added display of country when reviewing a user waypoint. Added sea surface temperature data. Added display of parachute jumping area. <p>System Software Version 2.90-3.00:</p> <ul style="list-style-type: none"> Added daylight savings time information display on Airport Waypoint page. <p>System Software Version 3.10-3.20 changes:</p> <ul style="list-style-type: none"> FlightCharts are no longer disabled after fade date. Added ability to import/export flight data via datacard. Added ability to highlight multiple weather objects using map cursor. Added XM page menu option for selecting a specific channel number. Added nearest airport page softkeys for toggling on/off private airports and heliports. Added TIS traffic data status indicator to the Map Page. <p>System Software Version 3.30-4.00 changes:</p> <ul style="list-style-type: none"> Added user-created checklists. Added support to export user waypoints and track logs to SD card. Added support for ChartView and geo-referenced FlightCharts. <p>System Software Version 4.20-4.30 changes:</p> <ul style="list-style-type: none"> Added SiriusXM warning text. Added menu options to WPT page for viewing departure and destination airports. Added displaced runway threshold distance on airport review page. Added suggested indicated altitude on E6B page.

Rev	Date	Description
E	March, 2012	<p>System Software Version 4.40-4.50 changes:</p> <ul style="list-style-type: none"> • Added AC-U-KWIK airport data support. <p>System Software Version 4.70-4.80 changes:</p> <ul style="list-style-type: none"> • Added display setup option to show/hide aircraft position on maps and charts. <p>System Software Version 4.80-4.90 changes:</p> <ul style="list-style-type: none"> • Added configurable data fields to display current climb gradient in percent or altitude gain per nautical mile. • Added runway number labels to runway extension lines on map. • Added Map Setup page items for adjusting visibility of water labels, park and land cover areas, runway numbers, and runway extension lines. • Added separate control for speed and distance units. • Added custom waypoint symbols support. • Changed screenshot utility to be activated when Menu key is pressed and held. • Changed XTK data fields display to more closely resemble G3X presentation. <p>Other changes:</p> <ul style="list-style-type: none"> • Changed XM to SiriusXM throughout. • Added TRAFFIC Softkey to Map Page Softkeys. • Added AOPA/DIRECTORY Softkey update info. • Added Terrain Page Softkeys. • Added Info Page Softkey. • Added Active Flight Plan Page Softkeys. • Added Flight Plan List Page Softkeys. • Added VNAV Page Softkeys. • Added Nearest Page Softkeys. • Updated AIRMETS and SIGMETS. • Added PIREP info. • Added Turbulence Forecast info. • Added Icing Forecast info. • Updated Chartview and FliteChart info. • Updated AOPA Airport Directory to just Airport Directory where applicable. • Updated System Messages. • Updated Data Field Options • Updated database information.

Rev	Date	Description
F	July, 2012	System Software Version 4.90-5.00 changes: <ul style="list-style-type: none">• Correct Disclaimer page database expiration date information• Correct missing 'Mark' waypoint operation (695 units only) System Software Version 5.00-6.00 changes: <ul style="list-style-type: none">• Added GDL 39 support
G	August, 2012	System Software Version 6.00-6.20 changes: <ul style="list-style-type: none">• Added TargetTrend™• Added GDL 39 Serial Pass-Through

SECTION 1 OVERVIEW	1
1.1 Unit Overview	1
Battery Care and Charging	2
Turning the Unit On/Off	4
GPS Receiver Status	6
1.2 GPSMAP 695/696 Controls	8
1.3 Accessing System Functionality	10
Menus	10
Data Entry	11
Pages	13
Main Page Softkeys	18
Flight Planning Softkeys	23
Nearest Page Softkeys	24
1.4 System Settings	25
Display	26
Sound	28
Units	29
Date & Time	30
Position	30
Interface	31
Alarms	31
Power	32
Setting Airport Criteria	33
Utilities	34
SECTION 2 GPS NAVIGATION	35
2.1 Introduction	35
Data Bar Fields	36
Compass Arc	38
2.2 Panel	40
Changing the CDI Scale	41
Setting the Bug Indicator	42
Manually Setting a Course	42
2.3 Vertical Navigation (VNAV)	43
Using the VNAV Feature	44
2.4 Using Map Displays	46
Map Orientation	47
Map Range	48
Map Panning	49
Measuring Bearing and Distance	51
Topography	52
Satellite View	53
Map Symbols	54

Airports & NAVAIDs.....	55
Cities & Roads	56
Airspace.....	57
Airways.....	57
2.5 Waypoints	60
Frequencies.....	63
Nearest Information	64
Weather Information	66
Intersections	68
NDBs.....	68
VORs	69
User Waypoints	70
2.6 Airspace	74
Airspace Alert Messages.....	75
Smart Airspace™.....	75
2.7 Direct-to Navigation	76
SECTION 3 FLIGHT PLANNING	79
3.1 Introduction	79
Data Fields.....	79
3.2 Flight Plan Creation	81
Adding Waypoints to an Existing Flight Plan.....	83
Graphical Flight Planning.....	85
3.3 Flight Plan Storage	88
3.4 Flight Plan Activation	89
Editing Speed and Fuel Flow.....	90
Copying Flight Plans.....	92
Deleting Flight Plans	92
Inverting a Flight Plan	94
Importing/Exporting Flight Plans.....	95
3.5 Approaches	96
Selecting an Approach.....	97
Activating Vectors-to-Final.....	100
3.6 Trip Planning	101
SECTION 4 HAZARD AVOIDANCE	103
4.1 Weather Information	103
SiriusXM Weather (696 only).....	104
Data Link weather (FIS-B).....	124
4.2 Terrain	141
Terrain Information.....	142
Obstacle Information.....	142
Terrain and Obstacle Color Code.....	143

Terrain Settings	143
Terrain Alerts	146
4.3 Traffic Information	148
Traffic Information Service (TIS-A)	149
Data Link Traffic (GDL 39).....	153
SECTION 5 ADDITIONAL FEATURES	167
5.1 SafeTaxi	167
SafeTaxi Cycle Number and Revision	169
5.2 ChartView (Optional)	169
Aircraft Symbol.....	172
Chart Range.....	173
Jeppesen Database-published NOTAMs	173
5.3 FliteCharts®	174
Chart Range.....	177
Aircraft Symbol.....	178
FliteCharts Cycle Number and Expiration Date	179
5.4 Airport Directory Data	180
5.5 SIRIUSXM Radio Entertainment (GPSMAP 696)	182
Activating SIRIUSXM Satellite Radio Services	182
Using SIRIUSXM Radio.....	183
5.6 Electronic Checklists	188
5.7 Flight Data Logging	188
SECTION 6 APPENDICES	189
Messages, Alerts & Data Field Options	189
System Messages	189
Airspace Messages	191
Aural Alerts	191
Data Field Options	192
Abnormal Operation	195
Resetting the Unit	195
Loss of GPS Position	195
Hazard Display with Loss of GPS Position.....	196
SD Card Use and Databases	197
SD Card Use.....	197
GPSMAP 695/696 Databases	198
Updating GPSMAP 695/696 Databases	202
Exporting Track Logs and User Waypoints.....	205
Importing/Exporting Flight Plans.....	205
Installation & Interfacing Information	207
Connecting the Power/Data Cable	207
Connecting to a Garmin VHF Comm Radio.....	208

Connecting to a Computer	209
Information about USB Drivers	210
Using xImage for Customized Waypoint Symbols.....	210
Connecting the GXM 40 Antenna (GPSMAP 696)	210
Interfacing	211
Connecting to a GTX 330 Mode S Transponder	213
Connecting to a GDL 39.....	214
Using an external GPS Antenna (Optional).....	219
General TIS-A Information	221
TIS-A vs. TAS/TCAS	221
TIS-A Limitations.....	222
Utilities	225
Flight Log.....	225
Track Log	227
Heading Line.....	230
Aircraft Profile.....	234
Weight & Balance	236
EPE Circle	237
Proximity Waypoints	238
Display Symbols	241
VFR Symbols	241
IFR Symbols	242
Airspace Symbols	244
Map Datum and Location Formats	247
Map Datums.....	247
Location Formats.....	247
Glossary	249
License Agreement and Warranty	255
Contact Garmin.....	255
Software License Agreement.....	255
Limited Warranty.....	255
AOPA Airport Directory Notice	256
AC-U-KWIK LICENSE AGREEMENT.....	256
Weather Data Warranty.....	257
SiriusXM Satellite Radio Service Agreement	258
FCC Compliance.....	258
Industry Canada Compliance	258
Index	Index-1

SECTION 1 OVERVIEW

1.1 UNIT OVERVIEW

The GPSMAP 695/696 presents GPS-derived analog flight instrumentation, position, navigation, and hazard avoidance information to the pilot using a 7" Wide VGA (800x480) color display.

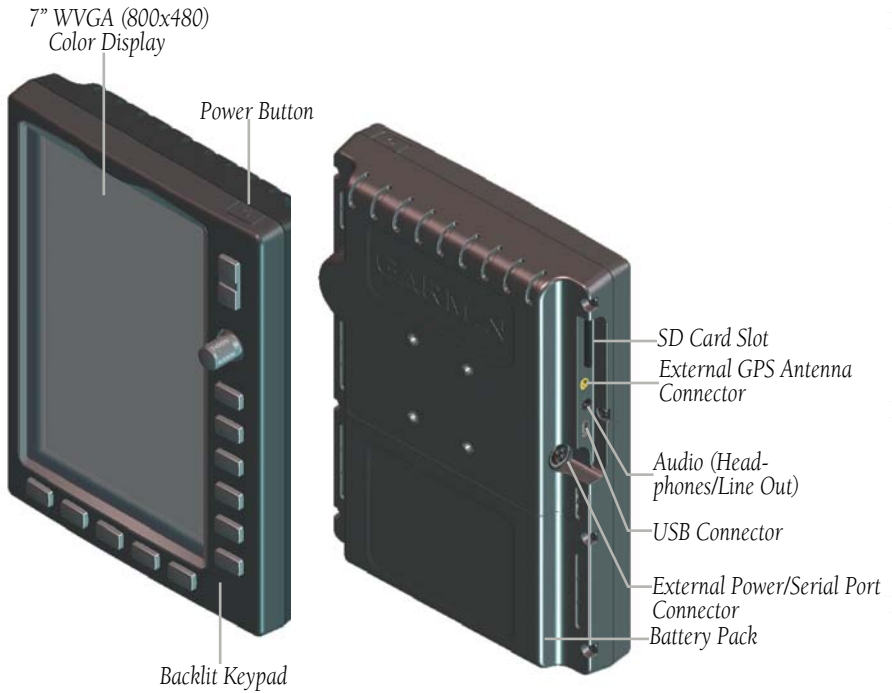

Unit Overview

BATTERY CARE AND CHARGING

BATTERY WARNINGS

If these guidelines are not followed, the internal Nickel Metal Hydride battery may experience a shortened life span or may present a risk of damage to the GPS unit, fire, chemical burn, electrolyte leak, and/or injury.

- Contact your local waste disposal department to properly recycle/dispose of the unit/battery.
- Do not leave the unit exposed to a heat source or in a high temperature location, such as in the sun in an unattended aircraft on a hot day. To prevent damage, remove the unit from the aircraft or store it out of direct sunlight.
- Do not disassemble, puncture, damage, or incinerate the unit/battery.
- When storing the unit for a limited length of time (less than 30 days), store within the following temperature range: -68° to 122°F (-20° to 50°C). When storing the unit for an extended time, store within the following temperature range: -68° to 86°F (-20° to 30°C).
- Do not operate the unit outside of the following temperature range: -68° to 140°F (-20° to 60°C).
- Keep the used battery away from children.

ADDITIONAL USER-REPLACEABLE BATTERY WARNINGS

- Do not use a sharp object to remove the battery.
- Do not recharge the battery out of the unit.
- Only replace with a Garmin Nickel Metal Hydride battery pack. Using another battery presents a risk of fire or explosion. To purchase a replacement battery, see your Garmin dealer or the Garmin Web site.

ADDITIONAL NON-USER-REPLACEABLE BATTERY WARNINGS

- Do not remove or attempt to remove the non-user-replaceable battery.
- When disposing of the unit, take it to a professional service, such as a waste electronics treatment facility, to have the battery removed and recycled.

INSERTING/REMOVING THE BATTERY PACK

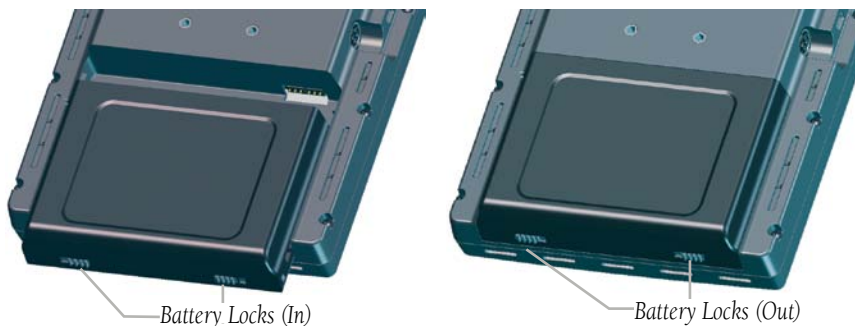

Inserting the Battery Pack

CHARGING THE BATTERY PACK

Plug the unit into a 12-Volt or 24-Volt connector to charge. The unit can be used while it is charging. Charge the unit within the following temperature range: 32° to 104°F (0° to 40°C).

Charging the unit's battery pack:

- 1) Align the notches on the unit with the vehicle power cable plug.
- 2) Push the plug into the external power connector until fully seated.
- 3) Plug the power cable into the aircraft power outlet (cigarette lighter receptacle).
- 4) Route the power cable so that it does not interfere with aircraft operation.

The unit begins charging as soon as external power is applied. When the unit in Charge Mode it reduces the draw on the aircraft's battery.

USING CHARGE MODE



NOTE: While in Charge Mode, the unit draws a current from the aircraft. To avoid discharging the aircraft's battery, disconnect the external power cable from the unit when not in use for several days.

Applying external power to the GPSMAP 695/696 automatically turns on the unit for full operation. If the battery is present and needs to be charged, the external power source charges the battery while the unit is in use.

If you do not want to use the unit, but you would like to charge the battery, you can put the unit into Charge Mode. Connect the unit to an external power supply. Press and hold the **POWER** Button. Instead of completely turning off, the unit now goes into Charge Mode.

TURNING THE UNIT ON/OFF

Press and hold the **POWER** Button to turn the unit on or off.



NOTE: If the display appears dark or dim, adjust the display backlighting as necessary upon power up. The GPSMAP 695/696 retains the backlighting settings between power cycles. Backlighting may have been set to a level not suitable for the current ambient lighting. For more information on display backlighting see section 1.4 (System Settings).

The power button can be used to quickly set the backlight intensity. A momentary press of the power button (after the unit is powered on) will display a window showing the current backlight setting. From this window the backlight setting can be adjusted with the joystick knob, or a second momentary press of the power button changes the backlight level to full bright (10).

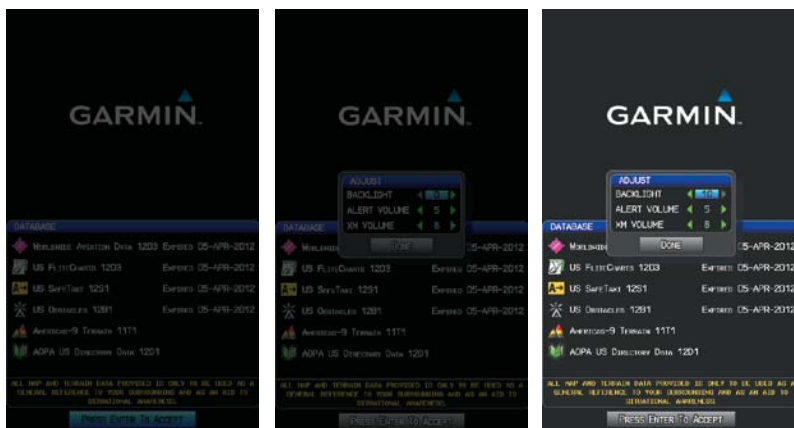

Adjusting Backlighting on Power up

The first time the unit is turned on, the receiver must collect satellite data and establish its present location. To ensure proper initialization, the GPSMAP 695/696 is shipped from the factory in AutoLocate mode, which allows the receiver to “find itself” anywhere in the world.

During initialization, current database information is displayed. Database information includes valid operating dates, cycle number, and database type. When this information has been reviewed for currency (to ensure that no databases have expired), the pilot is prompted to continue.

Press the **ENT** Key to acknowledge this information.

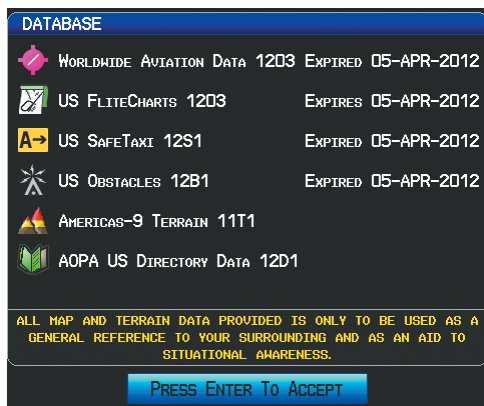

Database Initialization

After acknowledgement of the database information, the pilot is prompted to acknowledge a data link weather advisory.

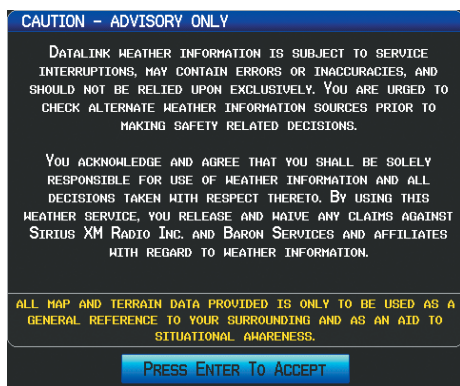

Data link Weather Advisory

Press the **ENT** Key to acknowledge this information.

GPS RECEIVER STATUS

The receiver status field on the INFO Page displays one of the following conditions:

- Autolocate—Receiver is looking for any satellite whose almanac has been collected, which can take up to 5 minutes
- Searching the Sky—Receiver is looking for satellites
- Acquiring Satellites—Receiver is looking for and collecting data from satellites visible at its last known or initialized location, but has not acquired a fix
- 2D GPS Location—At least three satellites have been acquired and a two-dimensional location fix has been calculated. “2D Differential” appears when you are receiving DGPS corrections in 2D mode
- 3D GPS Location—At least four satellites have been acquired and a three-dimensional fix has been calculated. “3D Differential” appears when you are receiving DGPS corrections in 3D mode
- Lost Satellite Reception—the receiver is no longer tracking enough satellites for a 2D or 3D fix

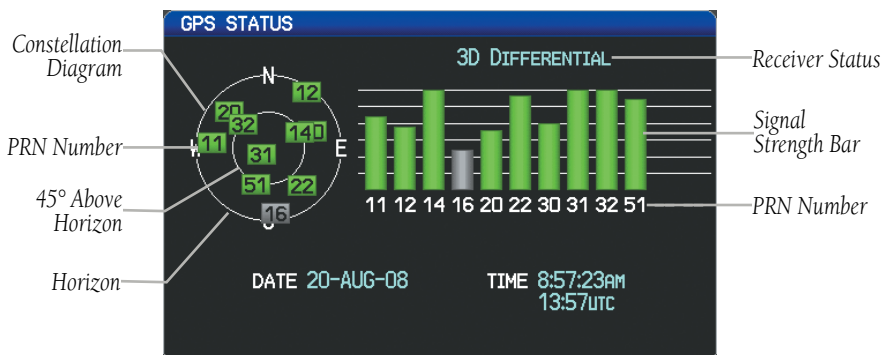

GPS Status (Info Page)

ACQUIRING SATELLITES

When the receiver is in the process of acquiring enough satellite signals for navigation, the receiver uses satellite orbital data (collected continuously from the satellites) and last known position to determine the satellites that should be in view. 'Acquiring Satellites' is indicated as the solution until a sufficient number of satellites have been acquired for computing a solution.

When the receiver is in the process of acquiring a 3D differential GPS solution, '3D GPS Location' is indicated as the solution until the 3D differential fix has finished acquisition.

SATELLITE INFORMATION

Satellites currently in view are shown at their respective positions on a satellite constellation diagram. The outer circle of the constellation diagram represents the horizon, the inner circle represents 45° above the horizon, and the center point shows the position directly overhead. Each satellite is represented by a square containing the Pseudo-Random Noise (PRN) number (i.e., satellite identification number).

The INFO Page can be helpful in troubleshooting weak (or missing) signal levels due to poor satellite coverage or installation problems. As the GPS receiver locks onto satellites, a signal strength bar is displayed for each satellite in view, with the appropriate satellite PRN number (01-32 or 33-64 for WAAS) below each bar. The progress of satellite acquisition is shown in three stages, as indicated by signal bar appearance:

- No bar—Receiver is looking for the indicated satellite
- Gray bar—Receiver has collected the necessary data and the satellite signal can be used
- Green bar—Satellite is being used for the GPS solution

1.2 GPSMAP 695/696 CONTROLS

The GPSMAP 695/696 controls have been designed to simplify operation of the system and minimize workload and the time required to access sophisticated functionality.

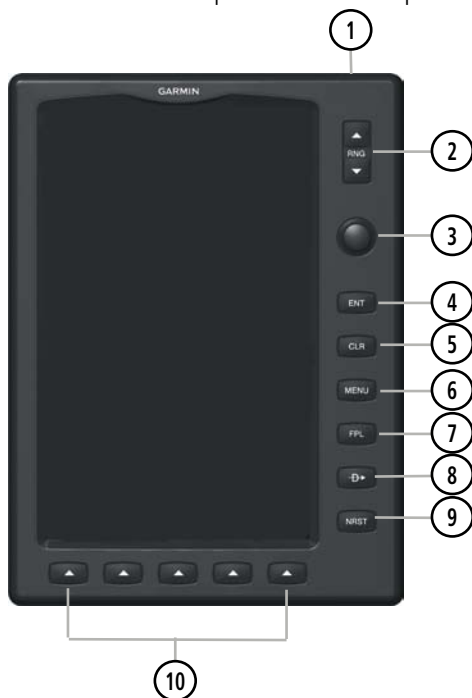

Controls

- ① **Power Button**
- ② **RNG Key**
- ③ **FMS Joystick**

Press and hold to turn the unit on or off

With the unit on, press to adjust the backlight and volume

Press to increase or decrease the viewing range of the map

Press the **FMS** Joystick to toggle input focus between user interaction with the current page and the page navigation bar
Turn the **FMS** Joystick clockwise to access a dropdown menu
Turn the **FMS** Joystick to change the selected value within the highlighted field

Move the **FMS** Joystick to highlight fields or move the map pointer when interacting with the page

- ④ **ENT Key** Press to confirm menu selection or data entry
Press to acknowledge messages
Press and hold to mark a waypoint
- ⑤ **CLR Key** Press to cancel an entry, revert to the previous value in a data entry field or remove menus
Press and hold to return to the default page
- ⑥ **MENU Key** Press once to view the Page Menu
Press twice to view the Main Menu
Press a third time to clear the Main Menu
- ⑦ **FPL Key** Press to display the Flight Plan Page
Press a second time to remove the Flight Plan Page
- ⑧ **Direct-To Key** Press to activate the Direct-To function, enter a destination waypoint and establish a direct course to the selected destination
- ⑨ **NRST Key** Press to display the Nearest Page for viewing the nearest airports, intersections, NDBs, VORs, waypoints, frequencies, and airspaces
- ⑩ **Softkey Selection Keys** Press to select the softkey shown above the bezel key on the unit

1.3 ACCESSING SYSTEM FUNCTIONALITY

MENUS

The GPSMAP 695/696 has a dedicated **MENU** Key that when pressed once displays a context-sensitive list of options for the page (Page Menu), and when pressed twice displays the Main Menu.

The Page Menu allows the user to access additional features or make settings changes which specifically relate to the currently displayed window/page. Menus display 'No Options' when there are no options for the window/page selected.

Navigating the Page Menu:

- 1) Press the **MENU** Key once to display the Page Menu.
- 2) Turn or move the **FMS** Joystick to scroll through a list of available options (a scroll bar always appears to the right of the window/box when the option list is longer than the window/box).
- 3) Press the **ENT** Key to select the desired option.
- 4) Press the **FMS** Joystick, the **CLR** Key, or the **MENU** Key twice to remove the menu and cancel the operation.

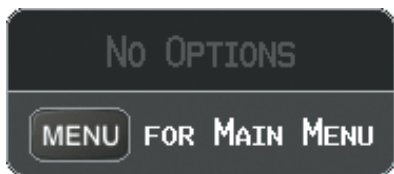

Page Menu (No Options)



Terrain (TER) Page Menu

Navigating the Main Menu:

- 1) Press the **MENU** Key twice to display the Main Menu.
- 2) Turn or move the **FMS** Joystick to scroll through a list of available options (a scroll bar always appears to the right of the window/box when the option list is longer than the window/box).
- 3) Press the **ENT** Key to select the desired option.
- 4) Press the **FMS** Joystick, the **CLR** Key, the **EXIT** Softkey, or the **MENU** Key to remove the menu and cancel the operation.



Main Menu

DATA ENTRY

The **FMS** Joystick can be used for directly entering alphanumeric data into the GPSMAP 695/696. In some instances, such as when entering an identifier, the GPSMAP 695/696 tries to predict the desired identifier based on the characters being entered. In this case, if the desired identifier appears, use the **ENT** Key to confirm the entry without entering the rest of the identifier manually. This can save the pilot from having to enter all the characters of the identifier.

Besides character-by-character data entry, the system also provides a shortcut for entering waypoint identifiers. When the cursor is on a field awaiting entry of a waypoint identifier, turning the **FMS** Joystick counter-clockwise accesses a menu with three different lists of identifiers for quick selections: recent waypoints (RECENT WPTS), nearest airports (NRST APTS), and flight plan waypoints (FPL WPTS). The GPSMAP 695/696 automatically fills in the identifier, facility and city fields with the information for the selected waypoint.

Using the FMS Joystick to enter data:

- 1) Press the **FMS** Joystick to activate the cursor.
- 2) Move the **FMS** Joystick to highlight the desired field.
- 3) Begin entering data.
 - a) To quickly enter a waypoint identifier, turn the **FMS** Joystick counter-clockwise to display a list of recent waypoints (RECENT WPTS), nearest airports (NRST APTS), or flight plan waypoints (FPL WPTS).
 - b) Move the **FMS** Joystick to highlight the desired waypoint from the list and press the **ENT** Key.

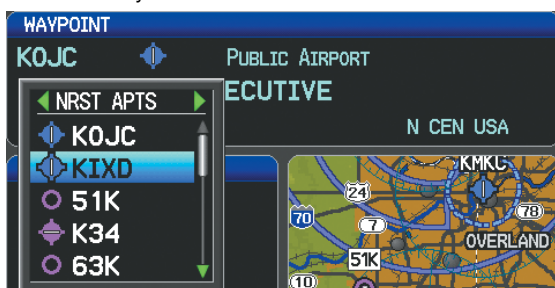

Waypoint Entry (Waypoint Page)

Or:

- a) Turn the **FMS** Joystick to select a character for the first placeholder.



Data Entry

Turning the **FMS** Joystick clockwise scrolls through the alphabet (where appropriate) toward the letter Z, starting in the middle at K (US only), and the digits zero through nine. Turning the **FMS** Joystick counter-clockwise scrolls in the opposite direction.

- b) Use the **FMS** Joystick to move the cursor to the next placeholder in the field.
 - c) Repeat, turning the **FMS** Joystick to select a character and using the **FMS** Joystick to move the cursor, until the fields are complete.
 - d) Press the **ENT** Key to confirm entry.
- 4) Press the **FMS** Joystick or the **CLR** Key to cancel data entry (the field reverts back to its previous information).

PAGES



NOTE: The Weather (WX) Page and (XM) Audio Page are only available with the GPSMAP 696.

The pages are linked together in a series that you can cycle through using the **FMS** Joystick. A page navigation bar is displayed in the lower portion of each page, directly above the softkey bar. The right side of the page navigation bar shows a list of abbreviated names for each of the main pages, and the left side shows the name of the active page.

Press the **FMS** Joystick to toggle input focus between the page navigation bar and interaction with the current page (i.e., turning the cursor on/off).

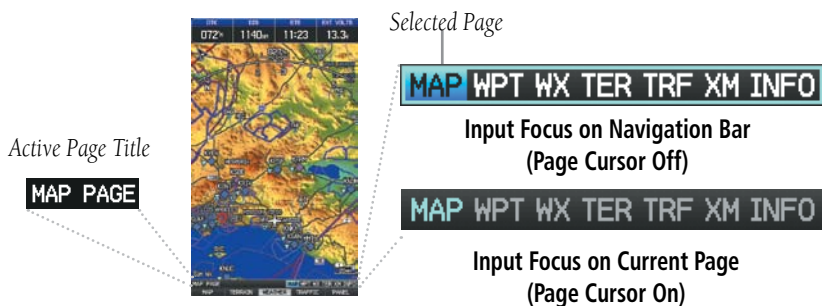

There are up to six main pages that can be navigated using the **FMS** Joystick.

Selecting a Main Page using the **FMS** Joystick:

- 1) If necessary press the **FMS** Joystick to begin interaction with the Navigation Bar.
- 2) Turn the **FMS** Joystick until the desired page is selected (**MAP**, **WPT**, **WX**, **TER**, **XM**, **INFO**).

• Main Pages

- Map Page (MAP)
- Waypoint Page (WPT)
- Weather Page (WX) (optional)
- Terrain Page (TER)
- Traffic Page (TRF)
- XM Audio Page (XM) (optional)
- Info Page (INFO)

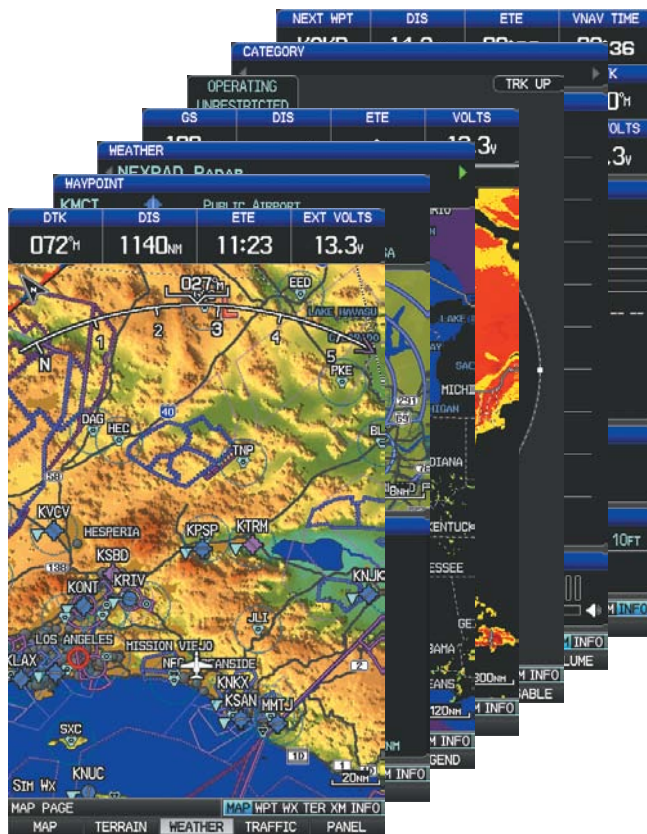

Overview

GPS Navigation

Flight Planning

Hazard Avoidance

Additional Features

Appendices

Index

FPL AND NRST PAGES

There are also several pages which are selected first by pressing the **FPL** Key or **NRST** Key.

Selecting the FPL or NRST Pages:

- 1) Press the **FPL** or **NRST** Key.
- 2) Turn the **FMS** Joystick until the desired page is selected.
- 3) Press the **EXIT** Softkey to return to the Main Pages.

The Nearest Pages contain the following information.

- APT (Airport)—identifier, bearing, distance, length of the longest runway, and common traffic advisory (CTAF) or tower frequency.
- VRP (Visual Reporting Point) (Atlantic Unit Only)—identifier, bearing, and distance.
- WX (Airport Weather)—identifier, bearing, distance, METAR text (GPSMAP 696 only), and ATIS, AWOS, or ASOS frequency.
- VOR (VHF Omnidirectional Radio Beacon)—identifier, facility type (symbol), bearing, distance, and frequency.
- NDB (Non Directional Beacons)—identifier, facility, type (symbol), bearing, distance, and frequency.
- INT (Intersection)—identifier, bearing, and distance.
- USR (User Waypoints)—name, bearing, and distance.
- CTY (City)—name, bearing, and distance.
- ATC (Air Route Traffic Control Center)—bearing, distance, and frequency.
- FSS (Flight Service Station)—name, bearing, distance, frequency, and VOR (if applicable).
- ASPC (Airspace)—name, time to entry (when applicable), and status.

• **Nearest Pages (NRST)**

- Nearest Airports (APT)
- Nearest User Waypoints (USR)
- Visual Reporting Point (VRP) (Atlantic Unit)
- Nearest Cities (CTY)
- Nearest Airport Weather (WX)
- Nearest ARTCC (ATC)
- Nearest VORs (VOR)
- Nearest FSS (FSS)
- Nearest NDBs (NDB)
- Nearest Airspace (ASPC)
- Nearest Intersections (INT)

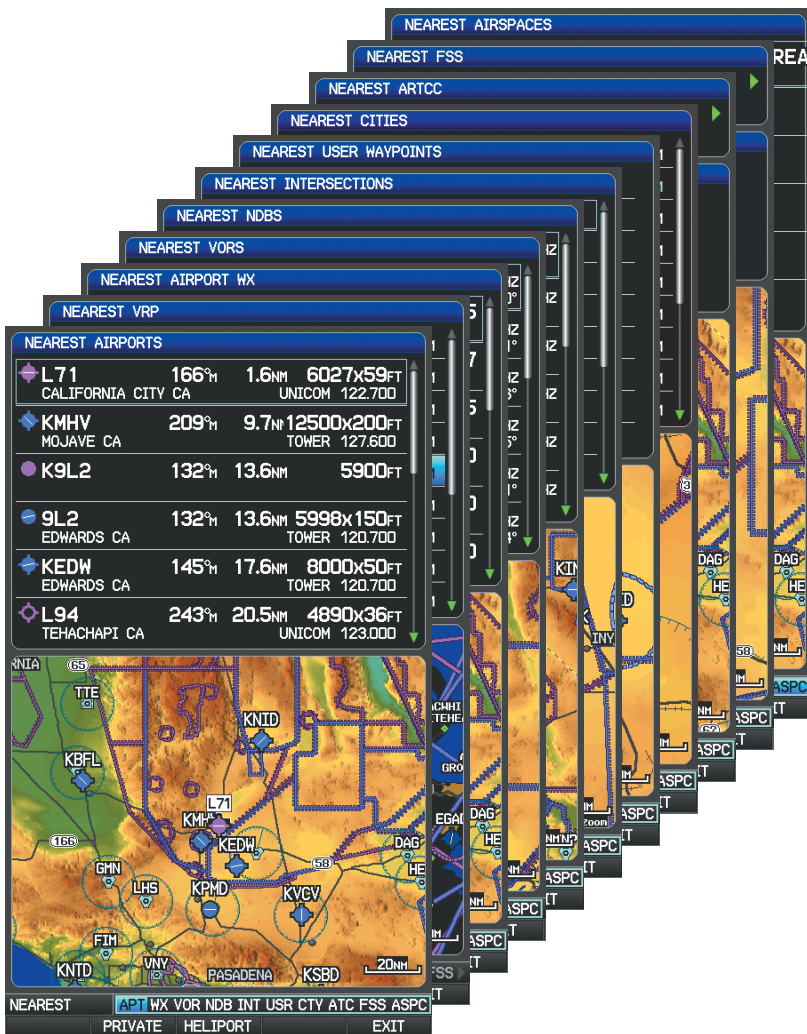

Overview

GPS Navigation

Flight Planning

Hazard Avoidance

Additional Features

Appendices

Index

- **Flight Planning Pages (FPL)**

Active Flight Plan (ACTV)

Vertical Navigation (VNAV)

Flight Plan List (LIST)

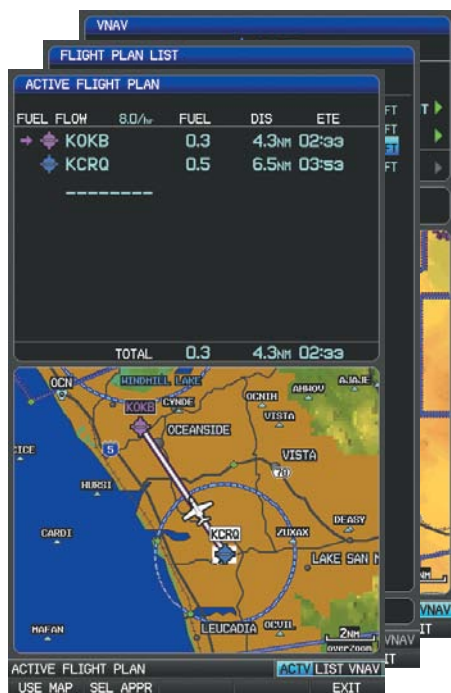

MAIN MENU PAGES

The Main Menu pages are accessed by pressing the Menu Key twice and using the **FMS** Joystick to navigate the menu.

Selecting the main menu pages:

- 1) Press the **MENU** Key twice. The Main Menu is displayed.
- 2) Turn or move the **FMS** Joystick to highlight the desired menu option and press the **ENT** Key.

SYSTEM SETUP PAGES

The System Setup pages are accessed from the Main Menu.

Selecting the system setup pages:

- 1) Press the **MENU** Key twice. The Main Menu is displayed.
- 2) Turn or move the **FMS** Joystick to highlight 'System Setup...' and press the **ENT** Key. The System Setup Menu is displayed.
- 3) Turn or move the **FMS** Joystick to highlight the desired menu option and press the **ENT** Key.

MAIN PAGE SOFTKEYS

The softkeys are located along the bottom of the display. The softkeys shown depend on the softkey level or page being displayed. The bezel keys below the softkeys can be used to select the appropriate softkey. When a softkey is selected, its color undergoes a momentary change to black text on blue background then automatically switches to black text on gray background and remains this way until it is turned off, at which time it reverts to white text on black background. When a softkey function is disabled, the softkey label is subdued (dimmed).



Softkeys (WPT Page)

MAP PAGE SOFTKEYS



- MAP Enables second-level Map Page softkeys
- TERRAIN Displays/removes terrain awareness information
- WEATHER Displays/removes weather information
- TRAFFIC Displays/removes traffic information
- PANEL Displays/removes the panel

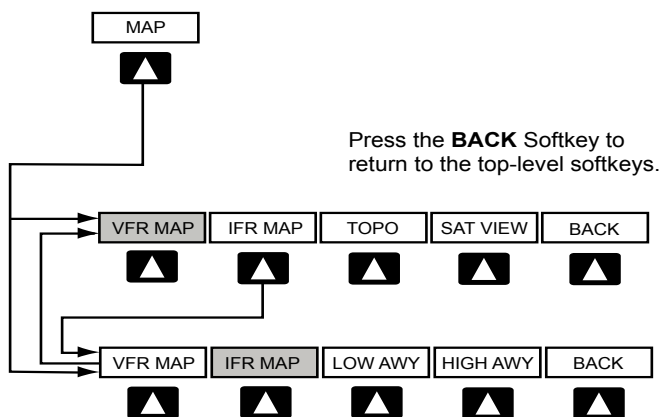

VFR MAP Softkey selected

- IFR MAP Displays IFR map information and softkeys
- TOPO Displays/removes topographical terrain shading
- SAT VIEW Displays/removes satellite imagery (above 20nm scale)
- BACK Returns to top-level softkeys

IFR MAP Softkey selected

- VFR MAP Displays VFR map information and softkeys
- LOW AWY Low Altitude (Victor) Airways displayed
- HIGH AWY High Altitude Airways (Jet Routes) displayed
- BACK Returns to top-level softkeys

WAYPOINT PAGE SOFTKEYS

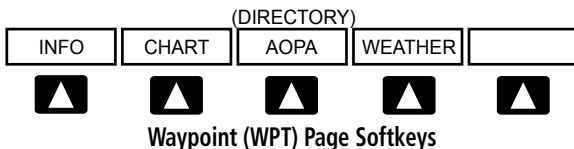

- INFO Displays waypoint information
- CHART Displays chart data (i.e., FliteCharts® or ChartView)
- AOPA or DIRECTORY Displays airport directory information
- WEATHER Displays METAR and TAF text (optional)

WEATHER PAGE SOFTKEYS (OPTIONAL)



- PAN MAP Activates the map pointer for panning the map
- SETUP Select the weather source (XM or FIS-B).
- ANIMATE Animates NEXRAD Radar and Satellite Mosaic weather
- INFO Displays XM Information
- LEGEND Displays weather legends

TERRAIN PAGE SOFTKEYS



- SETTINGS Displays the Terrain Setup Page
- DISABLE Toggles terrain alerts on/off.

TRAFFIC PAGE SOFTKEYS (OPTIONAL GDL 39)

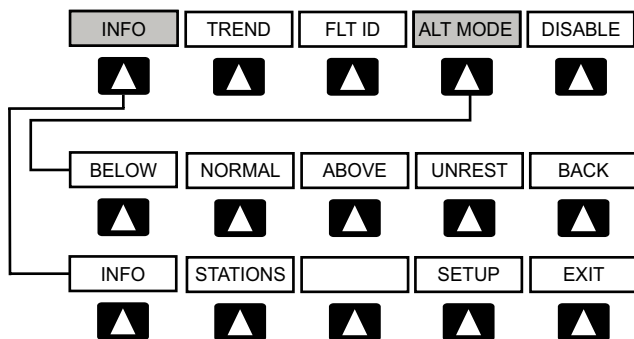

- INFO Select to view Data Link and Weather info
- TREND Displays TargetTrend™ traffic vectors.
- FLT ID Displays FLT ID information.
- ALT MODE Select to set altitude mode.
- DISABLE Temporarily disables traffic alerts

ALT MODE Softkey selected

- BELOW Displays non-threat and proximity traffic from 2700 feet above the aircraft to 9000 feet below the aircraft. Typically used during descent phase of flight.
- NORMAL Displays non-threat and proximity traffic from 2700 feet above the aircraft to 2700 feet below the aircraft. Typically used during enroute phase of flight.
- ABOVE Displays non-threat and proximity traffic from 9000 feet above the aircraft to 2700 feet above the aircraft. Typically used during enroute phase of flight.
- UNREST (Unrestricted): All traffic is displayed.

INFO Softkey selected

- STATIONS Displays ADS-B ground station(s) information.
- SETUP Select to set pressure altitude sensor on or off in the GDL 39.
- EXIT Returns to the Traffic Page.

SIRIUSXM AUDIO PAGE SOFTKEYS (OPTIONAL)



- INFO Displays SiriusXM Information
- CATEGORY Highlights the Category field
- CHANNEL Highlights the Channels field
- FAVORITE Displays a list of favorite channels
- VOLUME Enables second-level VOLUME softkeys
Press and hold to toggle Mute on/off.

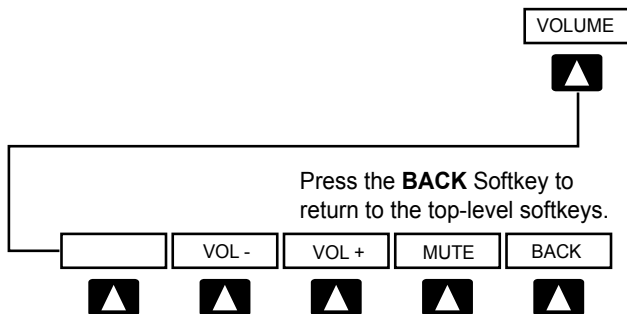

- VOL - Decreases SiriusXM audio volume
- VOL + Increases SiriusXM audio volume
- MUTE Toggles SiriusXM audio on/off
- BACK Returns to top-level softkeys

INFO PAGE SOFTKEY



- MESSAGES Displays system status messages

FLIGHT PLANNING SOFTKEYS

ACTIVE FLIGHT PLAN PAGE SOFTKEYS



USE MAP

Activates the Map Pointer

SEL APPR

Displays the Select Approach Window

EXIT

Exits the Flight Plan Pages

FLIGHT PLAN LIST PAGE SOFTKEYS



ACTIVATE

Displays the 'Activate Flight Plan?' Window

NEW

Displays the 'New Flight Plan' Window

IMPORT

Displays the available flight plans to import from the SD Card

EXPORT

Exports the selected flight plan

EXIT

Exits the Flight Plan Pages

VERTICAL NAVIGATION (VNAV) PAGE SOFTKEYS



CAPTURE

Captures/cancels VNAV profile

EXIT

Exits the Flight Plan Pages

NEAREST PAGE SOFTKEYS

NEAREST AIRPORT PAGE SOFTKEYS



PRIVATE Displays/removes the nearest private airports

HELIPORT Displays/removes the nearest heliports

EXIT Exits the Nearest Pages

Various softkeys revert to the previous level after 45 seconds of inactivity (e.g., PAN MAP, VOLUME, etc), other softkeys require manual de-selection (e.g., TERRAIN, WEATHER, PANEL, etc.).

1.4 SYSTEM SETTINGS

The System Setup Menu in the Main Menu allows management of the following system parameters:

- Display
- Sound
- Units
- Date & Time
- Position
- Interface
- Alarms
- Power



System Setup Menu

Restoring system setting defaults:

- 1) Press the **MENU** Key twice to display the Main Menu.
- 2) Turn or move the **FMS** Joystick to highlight 'System Setup...' and press the **ENT** Key.

- 3) Turn or move the **FMS** Joystick to highlight the desired menu option (Display, Sound, Units, Date & Time, Position, Interface, Alarms, or Power), and press the **ENT** Key.
- 4) Press the **MENU** Key.
- 5) With the 'Restore Default' highlighted press the **ENT** Key.



Restore Default Window

DISPLAY

BACKLIGHTING



NOTE: The GPSMAP 695/696 retains the backlighting settings between power cycles. Backlighting may have been set to a level not suitable for the current ambient lighting.

The large color display can be set to various brightness levels to allow for easy viewing in full sunlight or dimmed for night viewing. The power button can be used to quickly set the backlight intensity. By momentarily pressing the power button (when the unit is powered on) a window appears showing the current backlight setting. From this window the backlight setting can be adjusted with the joystick knob, or a second momentary press of the power button changes the backlight level to full bright (10). This provides a display which can be read under most lighting conditions. Once this method of changing the backlight to full bright has been used, the previously selected value is lost and the new backlight level is (10) and will remain at (10) until it is manually adjusted.

Adjusting display backlighting:

- 1) Press the **MENU** Key twice to display the Main Menu.
- 2) Turn or move the **FMS** Joystick to highlight 'System Setup...' and press the **ENT** Key.
- 3) With 'Display' highlighted press the **ENT** Key.

- 4) With the 'Backlight Intensity' field highlighted adjust the intensity by turning the **FMS** Joystick.
- 5) Press the **FMS** Joystick, the **CLR** Key, the **EXIT** Softkey or the **MENU** Key to remove the menu.



Display Setup Page

Or:

- 1) Momentarily Press the **POWER** Button.
- 2) With the 'Backlight' field highlighted adjust the intensity by turning the **FMS** Joystick.

Or: Momentarily Press the **POWER** Button again to automatically set the backlight intensity to full bright (10). The display will remain at full bright until manually adjusted.

- 3) With 'Done' highlighted press the **ENT** Key.
- 4) Press the **FMS** Joystick, or the **CLR** Key to remove the menu.

BACKLIGHT TIMEOUT

After a specified period of inactivity the backlight will turn off to save battery power.

Adjusting backlight timeout:

- 1) Press the **MENU** Key twice to display the Main Menu.
- 2) Turn or move the **FMS** Joystick to highlight 'System Setup...' and press the **ENT** Key.
- 3) With 'Display' highlighted press the **ENT** Key.

- 4) With the 'Backlight Timeout' field highlighted adjust the time by turning the **FMS** Joystick.
- 5) Press the **FMS** Joystick, the **CLR** Key, the **EXIT** Softkey or the **MENU** Key to remove the menu.

SCREENSHOTS

Enabling/disabling Screenshots:

- 1) Press the **MENU** Key twice to display the Main Menu.
- 2) Turn or move the **FMS** Joystick to highlight 'System Setup...' and press the **ENT** Key.
- 3) Turn or move the **FMS** Joystick to highlight 'Display', and press the **ENT** Key.
- 4) Move the **FMS** Joystick to highlight the Screenshot field.
- 5) Turn the **FMS** Joystick to highlight 'Enabled' or 'Disabled'.

Saving a Screenshot:

- 1) With screenshots enabled (see above), navigate to the desired screen.
- 2) Press and hold the **MENU** Key until the screen flashes indicating the screenshot was saved to the SD Card.

AIRCRAFT POSITION ON MAP/CHARTS

Displaying/removing the aircraft position on maps/charts:

- 1) Press the **MENU** Key twice to display the Main Menu.
- 2) Turn or move the **FMS** Joystick to highlight 'System Setup...' and press the **ENT** Key.
- 3) With 'Display' highlighted press the **ENT** Key.
- 4) With the 'Aircraft Position' field highlighted, turn the **FMS** Joystick to select 'Hide' or 'Show' and press the **ENT** Key.

SOUND

Adjusting sound:

- 1) Press the **MENU** Key twice to display the Main Menu.
- 2) Turn or move the **FMS** Joystick to highlight 'System Setup...' and press the **ENT** Key.
- 3) Turn or move the **FMS** Joystick to highlight 'Sound' and press the **ENT** Key.

- 4) With the desired option highlighted, adjust the sound by turning the **FMS Joystick**.
- 5) Press the **FMS Joystick**, the **CLR Key**, the **EXIT Softkey** or the **MENU Key** to remove the menu.

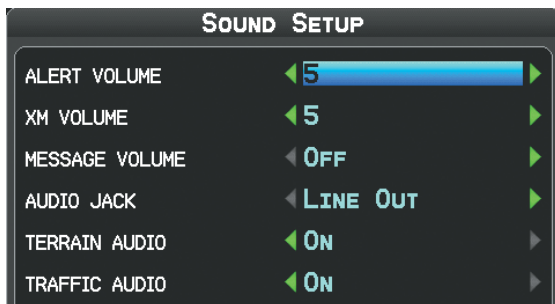

Sound Setup Page

UNITS

Changing display unit settings:

- 1) Press the **MENU Key** twice to display the Main Menu.
- 2) Turn or move the **FMS Joystick** to highlight 'System Setup...' and press the **ENT Key**.
- 3) Turn or move the **FMS Joystick** to highlight 'Units' and press the **ENT Key**.
- 4) With the desired unit highlighted adjust the unit measurement by turning the **FMS Joystick**.
- 5) Press the **FMS Joystick**, the **CLR Key**, the **EXIT Softkey** or the **MENU Key** to remove the menu.

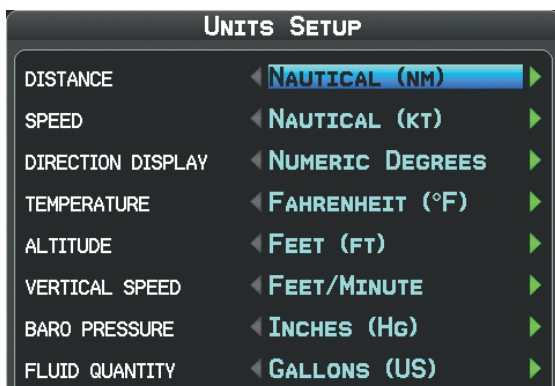

Units Setup Page

DATE & TIME

Changing date & time settings:

- 1) Press the **MENU** Key twice to display the Main Menu.
- 2) Turn or move the **FMS** Joystick to highlight 'System Setup...' and press the **ENT** Key.
- 3) Turn or move the **FMS** Joystick to highlight 'Date & Time' and press the **ENT** Key.
- 4) Move the **FMS** Joystick to highlight the desired field, and select the desired option by turning the **FMS** Joystick.
- 5) Press the **FMS** Joystick, the **CLR** Key, the **EXIT** Softkey or the **MENU** Key to remove the menu.

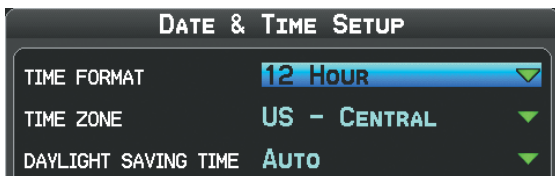

Date & Time Setup Page

POSITION



NOTE: Refer to Appendix H for more information on Map Datums and Location Formats.

Changing position settings:

- 1) Press the **MENU** Key twice to display the Main Menu.
- 2) Turn or move the **FMS** Joystick to highlight 'System Setup...' and press the **ENT** Key.
- 3) Turn or move the **FMS** Joystick to highlight 'Position' and press the **ENT** Key.
- 4) Move the **FMS** Joystick to highlight the desired field, and select the desired option by turning the **FMS** Joystick.
- 5) Press the **FMS** Joystick, the **CLR** Key, the **EXIT** Softkey or the **MENU** Key to remove the menu.

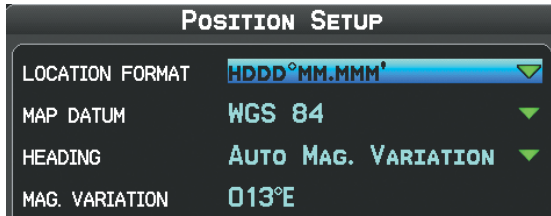

Position Setup Page

INTERFACE



NOTE: Refer to Appendix D for more information on Interfacing.

Changing interface settings:

- 1) Press the **MENU** Key twice to display the Main Menu.
- 2) Turn or move the **FMS** Joystick to highlight 'System Setup...' and press the **ENT** Key.
- 3) Turn or move the **FMS** Joystick to highlight 'Interface' and press the **ENT** Key.
- 4) Turn the **FMS** Joystick to select the desired 'Serial Data Format'.
- 5) Press the **FMS** Joystick, the **CLR** Key, the **EXIT** Softkey or the **MENU** Key to remove the menu.

ALARMS

The Alarms Page allows the pilot to turn airspace alarms On/Off, set an Altitude Buffer, Arrival Alarm, Next Waypoint Alarm, Proximity Alarm, and Fuel Tank Reminder Alarm.

Changing alarm settings:

- 1) Press the **MENU** Key twice to display the Main Menu.
- 2) Turn or move the **FMS** Joystick to highlight 'System Setup...', and press the **ENT** Key.
- 3) Turn or move the **FMS** Joystick to highlight 'Alarms' and press the **ENT** Key.
- 4) Move the **FMS** Joystick to highlight the desired field, and select the desired option by turning the **FMS** Joystick.
- 5) Press the **FMS** Joystick, the **CLR** Key, the **EXIT** Softkey or the **MENU** Key to remove the menu.



Alarms Page

POWER

Turning the power loss warning on/off:

- 1) Press the **MENU** Key twice to display the Main Menu.
- 2) Turn or move the **FMS** Joystick to highlight 'System Setup...', and press the **ENT** Key.
- 3) Turn or move the **FMS** Joystick to highlight 'Power' and press the **ENT** Key.
- 4) Turn the **FMS** Joystick to select 'On' or 'Off', and press the **ENT** Key.

SETTING AIRPORT CRITERIA

The Page Menu on the Nearest Airports Page allows the pilot to filter out airports that do not meet a defined criteria. Specific surface types and runway lengths can be defined, as well as the option to include private airports and/or heliports.

Runway Surface—allows you to set criteria for the type of surface on the runway:

- Any—shows any runway, regardless of surface type, including water landing facilities.
- Hard Only—shows only runways with a concrete, asphalt, or similar sealed surface.
- Hard or Soft—shows all runways except water landing facilities.
- Water Only—shows only water landing facilities.

Minimum Runway Length—allows the pilot to enter a specific length for the shortest runway allowed.

Entering airport criteria:

- 1) Press the **NRST** Key.
- 2) Turn the **FMS** Joystick to select the Nearest Airports Page.
- 3) Press the **MENU** Key to display the Page Menu.
- 4) Turn or move the **FMS** Joystick to select 'Set Airport Criteria', and then press the **ENT** Key. The Airport Criteria Window appears with the current settings.



Nearest Airports Page Menu

- 5) Move the **FMS** Joystick to highlight the desired field and turn the **FMS** Joystick to select the desired option from the menu. Press the **ENT** Key if necessary to highlight the next field.

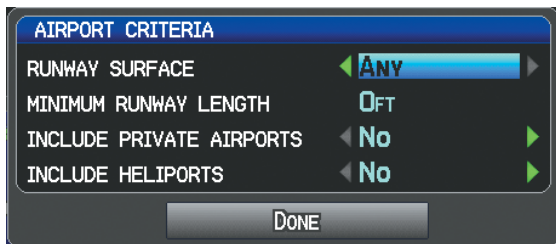

Airport Criteria Window

- 6) With 'Done' highlighted press the **ENT** Key.

To restore airport criteria defaults:

- 1) Press the **NRST** Key.
- 2) Turn the **FMS** Joystick to select the Nearest Airports Page.
- 3) Press the **MENU** Key to display the Page Menu.
- 4) Turn or move the **FMS** Joystick to select 'Set Airport Criteria', and then press the **ENT** Key. A window appears with the current settings.
- 5) Press the **MENU** Key.
- 6) With 'Restore Default' highlighted press the **ENT** Key.

UTILITIES

Refer to Appendix F for information on Flight Log, Track Log, E6B, Aircraft Profile, and Weight & Balance.

SECTION 2 GPS NAVIGATION

2.1 INTRODUCTION

The Navigation Map displays aviation data (e.g., airports, VORs, airways, airspaces), geographic data (e.g., cities, lakes, highways, borders), and topographic data (map shading indicating elevation). The Navigation Map can be oriented three different ways: North Up (NORTH UP), Track Up (TRK UP), or Desired Track Up (DTK UP).

An aircraft icon is placed on the Navigation Map at the location corresponding to the calculated present position. The aircraft position and the flight plan legs are accurately based on GPS calculations. The basemap upon which these are placed are from a source with less resolution, therefore the relative position of the aircraft to map features is not exact. The leg of the active flight plan currently being flown is shown as a magenta line on the navigation map. The other legs are shown in white.

The Direct-to Window, the Flight Plan Pages, and the Nearest Airports Pages can be displayed by pressing the corresponding key.

The page layout of the Map, Terrain, and Info Pages can be independently configured by the user.

Page Layout	Map Page	Terrain Page	Info Page
Map Only	+	+	
Map with Panel	+		
4 Data Bar Fields	+	+	+
8 Data Bar Fields	+	+	+
12 Data Bar Fields	+	+	+
6 Data Bar Fields and HSI	+	+	

Page Layout

DATA BAR FIELDS

The number and content of the data bar fields on the Map, Terrain, and Info Pages are independently configured by the user. For each page that supports data bar fields the user may choose 0, 4, 8, 12, or 6 and the HSI (if available).

GS	DIS	ETE	VSR
100 _{KT}	2.3 _{NM}	01:21	____FPM [↑]

Data Bar Fields

By default, the Navigation Map Data Bar Fields are set to display ground speed (GS), distance (NEXT), estimated time enroute (ETE NEXT), and vertical speed required (VSR). These four data fields can be changed to display any of the Data Bar Field Options.

Changing the information shown in the data bar fields:

- 1) From the Map Page, Terrain Page, or the Info Page press the **MENU** Key.
- 2) Turn or move the **FMS** Joystick to highlight 'Change Data Fields' and press the **ENT** Key.
- 3) Move the **FMS** Joystick to highlight the desired data field.
- 4) Turn the **FMS** Joystick to access the list of options, then turn or move the **FMS** Joystick to highlight the desired option and press the **ENT** Key.

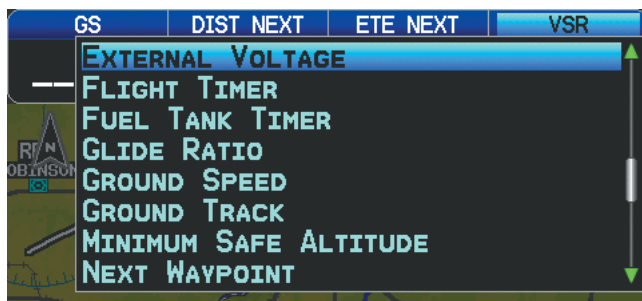

Data Bar Field Selection

DATA BAR FIELD OPTIONS

- Accuracy
- Altitude
- Battery
- Bearing (BRG)
- Climb Gradient (Alt Per NM) (CLIMB/NM)
- Climb Gradient (PERCENT)
- Course to Steer (CTS)
- Crosstrack Error (XTK)
- Desired Track (DTK)
- Distance (DESTINATION)
- Distance (NEXT)
- En Route Safe Altitude (ESA)
- Estimated Time En route (DESTINATION) (ETE DEST)
- Estimated Time Enroute (NEXT) (ETE NEXT)
- Estimated Time of Arrival (DESTINATION) (ETA DEST)
- Estimated Time of Arrival (NEXT) (ETA NEXT)
- Estimated Time to VNAV (VNAV Time)
- External Voltage (EXT VOLTS)
- Flight Timer (FLT TIMER)
- Fuel Tank Timer (FUEL TIMER)
- Glide Ratio (GLIDE RATIO)
- Ground Speed (GS)
- Ground Track (TRK)
- Minimum Safe Altitude (MSA)
- Next Waypoint (NEXT WPT)
- Sunrise
- Sunset
- Time (UTC)
- Time of Day (Local) (TIME)
- Vertical Speed (VS)
- Vertical Speed Required (VSR)
- Weather (Altimeter) (WX ALTIM)
- Weather (Dew Point) (WX DEW PT)
- Weather (Relative Humidity) (WX HUMIDITY)
- Weather (Temperature) (WX TEMP)
- Weather (Wind) (WX WIND)

Changing page layout:

- 1) From the Map Page, Terrain Page, or the Info Page press the **MENU** Key.
- 2) Turn or move the **FMS** Joystick to highlight 'Select Page Layout' and press the **ENT** Key.
- 3) Move the **FMS** Joystick to highlight the desired page layout option, and press the **ENT** Key.

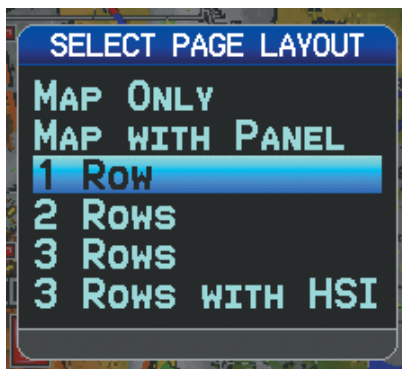

Page Layout Window (Map Page)

COMPASS ARC



NOTE: *The compass arc is not available in 'North Up' map orientation.*

A compass arc appears by default on the Map Page. The route line represents the course and the magenta bug indicator (similar to the bug indicator on the HSI) can be set to 'Bearing' (default), 'Course to Steer', a specific heading reference ('User Selected'), or 'Off'.

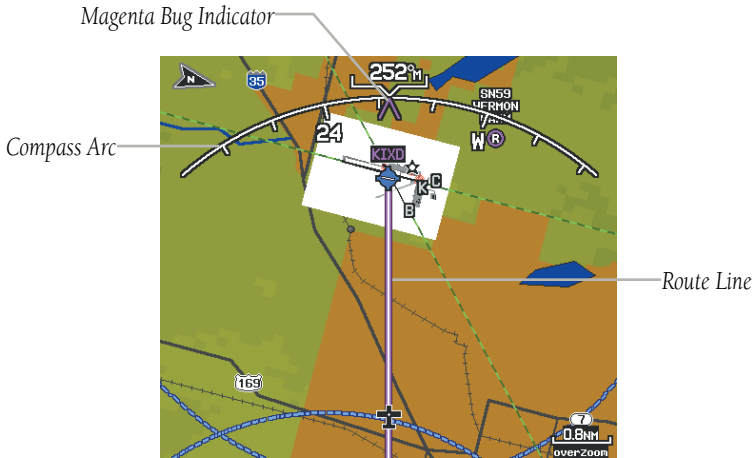

Compass Arc (Map Page)

Removing the Compass Arc from the Map Page:

- 1) With the Map Page displayed, press the **MENU** Key.
- 2) Turn or move the **FMS** Joystick to highlight 'Set Up Map' and press the **ENT** Key.
- 3) Turn the **FMS** Joystick to highlight the 'General' Menu.
- 4) Move the **FMS** Joystick to highlight the 'Compass Arc' field.
- 5) Turn the **FMS** Joystick to access the 'On/Off' drop down list.
- 6) Turn or move the **FMS** Joystick to highlight 'Off', and press the **ENT** Key.

2.2 PANEL

The panel shows GPS-derived data in a graphical format. Keep in mind the differences between the GPS-derived panel and mechanical instruments, as mechanical panel instruments use sensors that provide information different from that derived using GPS.

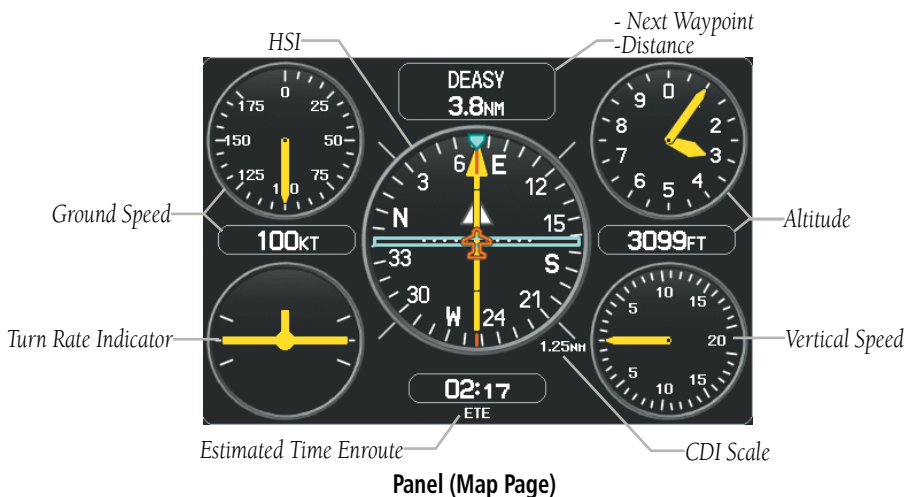

The Panel shows a graphic Horizontal Situation Indicator (HSI) surrounded by additional indicators.

The graphic HSI depicts the course to the destination or the next waypoint in a flight plan, current ground track, off course error, and a To/From indication. The rotating compass indicates your current ground track at the top of the page.

The course pointer and course deviation needle indicate the course and whether you are on the course. The Bug Indicator can be set to 'Bearing' (default), 'Course to Steer', a specific heading reference ('User Selected'), or 'Off'.

Bearing is the compass direction from the present position to a destination waypoint. Course to Steer is the recommended direction to steer in order to reduce cross-track error and return to the course line.

The Course Deviation Indicator, or needle, indicates how far off course, left or right, based on its placement along the course deviation scale.

The course deviation scale setting is adjustable for Auto, ± 0.25 , 1.25 or 5.0 (nautical mile, statute mile, or kilometer) full-scale deflection. The course deviation scale appears on the lower right corner of the HSI. The default setting is Auto, which uses three factors to determine the distance from the center of the CDI to full left or right limits:

- CDI scale = 1.25 - within 30 nm of any airport in the active route.
- CDI scale = 0.25 - on an approach leg or within 2 nm of the FAF or MAP.
- CDI scale = 5.0 - if the previous two conditions do not exist.

Displaying the panel on the map page:

From the Map Page press the **PANEL** Softkey.

Or:

- 1) From the Map Page press the **MENU** Key to display the Map Page Menu.
- 2) Turn or move the **FMS** Joystick to highlight 'Select Page Layout' and press the **ENT** Key.
- 3) Turn or move the **FMS** Joystick to highlight 'Map with Panel' and press the **ENT** Key.

CHANGING THE CDI SCALE

The CDI scale can be set from the Map Page Menu.

Changing the CDI scale:

- 1) From the Map Page with the Panel, HSI, or Compass Arc displayed, press the **MENU** Key to display the Map Page Menu
- 2) Turn or move the **FMS** Joystick to highlight 'Set CDI Scale', and press the **ENT** Key. The 'Set CDI Scale' Menu appears.
- 3) Turn or move the **FMS** Joystick to highlight the desired menu option, and press the **ENT** Key.



Map Page Menu

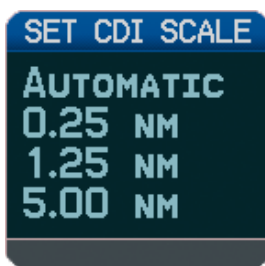

Set CDI Scale Menu

SETTING THE BUG INDICATOR

The Bug Indicator can be set from the Map Page Menu.

Setting the Bug Indicator:

- 1) From the Map Page with the Panel, HSI, or Compass Arc displayed, press the **MENU** Key to display the Map Page Menu.
- 2) Turn or move the **FMS** Joystick to highlight 'Set Bug Indicator', and press the **ENT** Key. The 'Set Bug Indicator' Menu appears.
- 3) Turn or move the **FMS** Joystick to highlight the desired menu option, and press the **ENT** Key. For the 'User Selected' option, turn the **FMS** Joystick to select the desired heading reference, and press the **ENT** Key.

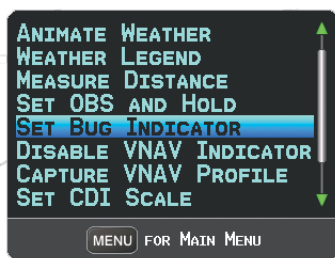

Map Page Menu

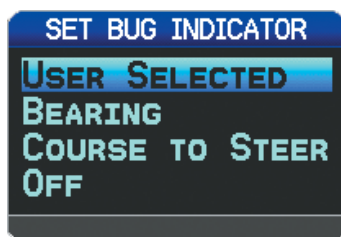

Set Bug Indicator Menu

MANUALLY SETTING A COURSE

Use the 'Set OBS and Hold' option to manually set your course to the destination.

Manually setting a course to the destination waypoint:

- 1) From the Map Page with the Panel, HSI, or Compass Arc displayed, press the **MENU** Key to display the Map Page Menu.
- 2) Turn or move the **FMS** Joystick to highlight 'Set OBS and Hold', and press the **ENT** Key.
- 3) Turn the **FMS** Joystick to select the desired course to the destination, and press the **ENT** Key.



Map Page Menu



Set OBS Window

Returning to automatic sequencing of route waypoints:

- 1) From the Map Page after manually setting a course, press the **MENU** Key to display the Map Page Menu
- 2) Turn or move the **FMS** Joystick to highlight 'Release Hold', and press the **ENT** Key.

2.3 VERTICAL NAVIGATION (VNAV)

The Vertical Navigation Page provides settings for the vertical navigation feature. These settings create a three-dimensional profile from the present location and altitude to a final (target) altitude at a specified location.

When the VNAV profile is defined, the pilot is informed of the progress by message alerts. The teal bar on the HSI (when displayed) shows the VNAV profile.

The Vertical Navigation feature is only available when navigating a Direct To or flight plan, and the ground speed is greater than 35 knots.

The "Approaching VNAV Profile" message appears one minute prior to the initial descent point. The descent angle locks to prevent changes in speed from altering the profile. The VNAV feature does not take into account any changes in groundspeed that occur during the transition from level flight to descent or climb.



At 500 ft above the target altitude, the "Approaching Target Altitude" message appears, the 'Estimated Time To VNAV' goes blank, and the VNAV indicator disappears from the HSI.

APPROACHING TARGET ALTITUDE



CAUTION: The GPSMAP 695/696 is a VFR navigation tool and should not be used to perform instrument approaches.



CAUTION: VNAV is only a VFR navigation aid and is not intended for instrument approaches.

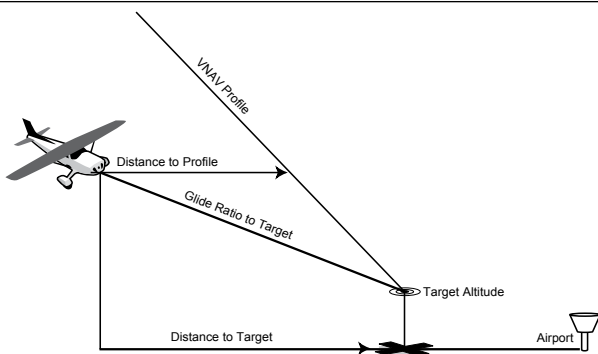

Visual Representation of VNAV

USING THE VNAV FEATURE

Use the VNAV (Vertical Navigation) feature to ensure the aircraft is at the proper altitude. The VNAV Indicator appears on the HSI (when displayed) as a horizontal teal bar. A message appears when approaching the VNAV Profile. When the bar is in the vertical center of the HSI, the aircraft is at the proper altitude for the VNAV Profile.

Configuring a VNAV profile:

- 1) While navigating a flight plan or direct-to, press the **FPL** Key.
- 2) Turn the **FMS** Joystick to select the Vertical Navigation Page.
- 3) Press the **FMS** Joystick to activate the cursor.
- 4) Enter the desired profile into the fields, and press the **EXIT** Softkey.

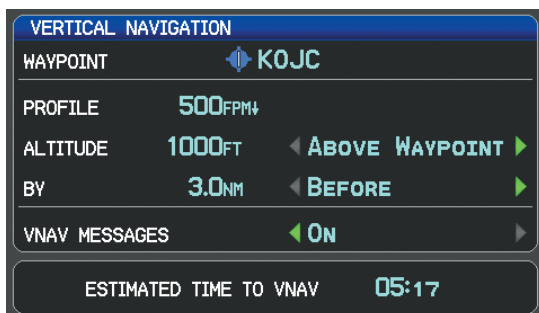

Vertical Navigation Page

- Waypoint—Enter any waypoint along the currently active route as the reference waypoint. The reference waypoint defines the target location.
- Profile—Enter the descent rate.
- Altitude—Enter the desired reference waypoint altitude. Select ‘Above Waypoint’ to use field elevation for airports in the Jeppesen database or ‘MSL’ to specify an exact MSL altitude target.
- By—Enter the target location with settings of distance ‘Before’ or ‘After’ a reference waypoint. To set a target location at a reference waypoint, enter a distance of zero.
- VNAV Messages—Select ‘On’ or ‘Off’ to enable/disable VNAV alert messages.

Enabling/disabling the VNAV indicator:

- 1) From the Map Page, press the **MENU** Key to display the Map Page Menu
- 2) Turn or move the **FMS** Joystick to highlight ‘Enable VNAV Indicator’ or ‘Disable VNAV Indicator’, and press the **ENT** Key.

Capturing/cancelling VNAV profile:

- 1) Enter a valid VNAV profile and begin navigation.
- 2) From the Map Page, press the **MENU** Key to display the Map Page Menu
- 3) Turn or move the **FMS** Joystick to highlight ‘Capture VNAV Profile’ or ‘Cancel Capture’, and press the **ENT** Key. Selecting ‘Capture VNAV Profile’ centers the VNAV indicator on the HSI (when displayed).



VNAV Indicator (Panel)

Configuring a VNAV profile:

- 1) Press the **FPL** Key.
- 2) Turn the **FMS** Joystick to select the Vertical Navigation Page.
- 3) Press the **FMS** Joystick to activate the cursor.
- 4) Enter the desired profile into the fields, and press the **EXIT** Softkey.

2.4 USING MAP DISPLAYS

Map displays are used extensively in the GPSMAP 695/696 to provide situational awareness in flight. Most GPSMAP 695/696 maps can display the following information:

- Airports, NAVAIDs, airspaces, airways, land data (highways, cities, lakes, rivers, borders, etc.) with names
- Map Pointer information (distance and bearing to pointer, location of pointer, name, and other pertinent information)
- Map range
- Aircraft icon (representing present position)
- Flight plan legs
- User waypoints
- Track vector

- Topography data

The information in this section applies to the following maps unless otherwise noted:

- Map Page (MAP)
- Waypoint Page (WPT) (**INFO** Softkey selected)
- Weather Page (WX)
- Terrain (TER)
- Nearest Pages (NRST)
- Active Flight Plan Page (FPL)
- Direct-to Window (map range only)

MAP ORIENTATION

Maps are shown in one of three different orientation options, allowing flexibility in determining aircraft position relative to other items on the map (North Up) or for determining where map items are relative to where the aircraft is going (Track Up), or desired track up (DTK UP)).

- North Up aligns the top of the map display to north (default setting).
- Track Up aligns the top of the map display to the current ground track.
- Desired Track (DTK) Up aligns the top of the map display to the desired course.



NOTE: *Map orientation can only be changed on the Map Page. Any other pages that show navigation data reflect the orientation selected for the Map Page.*

Changing the Navigation Map orientation:

- 1) With the Map Page displayed, press the **MENU** Key.
- 2) Turn or move the **FMS** Joystick to highlight 'Set Up Map' and press the **ENT** Key.
- 3) Turn the **FMS** Joystick to highlight the 'General' Menu.
 - a) Move the **FMS** Joystick to highlight the 'Orientation' field.

- b) Turn the **FMS** Joystick to access a list of available options.
- c) Turn or move the **FMS** Joystick to highlight 'North Up', 'Track Up', or 'DTK Up', and press the **ENT** Key.

Or:

- a) Move the **FMS** Joystick to highlight the 'North Up Above' field.
- b) Turn the **FMS** Joystick to access a list of available range options.
- c) Turn or move the **FMS** Joystick to highlight the desired range above which to display North Up orientation.

Or:

- a) Move the **FMS** Joystick to highlight the 'North Up On GRND' field.
- b) Using the **FMS** Joystick highlight 'On' or 'Off', and press the **ENT** Key. When 'North Up On GRND' is 'ON' (default), the map orientation will change to North Up when the aircraft is on the ground.

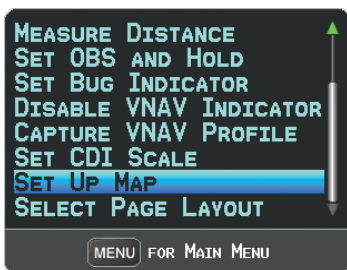

Map Page Menu

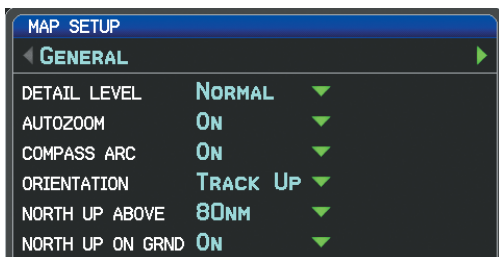

General Menu (Map Setup Page)

MAP RANGE



NOTE: Refer to the Additional Features section for information on changing the FliteCharts®, or ChartView range.

There are 23 different map ranges available, from 200 feet to 800 nm. The current range is indicated in the lower right corner of the map. The scale bar represents the map scale. To change the map range on any map, use the down arrow on the **RNG** Key to zoom in (decreasing), or the up arrow to zoom out (increasing).

When the selected range exceeds the resolution of the map data, 'overzoom' appears below the map range scale.



Scale Bar Representing a Map Scale of 1.2 nm Per Scale Width.

Map Range/Overzoom

AUTO ZOOM

Auto Zoom allows the GPSMAP 695/696 to change the map display range to the smallest range clearly showing the active waypoint. Auto Zoom can be overridden by adjusting the range and remains that way until the active waypoint changes, a terrain or traffic alert occurs, or the aircraft takes off.

Enabling/disabling autozoom:

- 1) With the Map Page displayed, press the **MENU** Key.
- 2) Turn or move the **FMS** Joystick to highlight 'Set Up Map' and press the **ENT** Key.
- 3) Turn the **FMS** Joystick to highlight the 'General' Menu.
- 4) Move the **FMS** Joystick to highlight the 'Autozoom' field.
- 5) Turn the **FMS** Joystick to access the 'On/Off' drop down list.
- 6) Turn or move the **FMS** Joystick to highlight the desired option, and press the **ENT** Key.

MAP PANNING

Map panning allows the pilot to:

- View parts of the map outside the displayed range without adjusting the map range
- Highlight and select locations on the map
- Review information for a selected airport, NAVAID, or user waypoint
- Designate locations for use in flight planning
- View airspace and airway information

When the panning function is selected by pressing the **FMS Joystick (PAN MAP Softkey on the Weather Page)** the Map Pointer flashes on the map display. A window also appears at the top of the map display showing the latitude/longitude position of the pointer, the bearing and distance to the pointer from the aircraft's present position, the elevation of the land at the position of the pointer, or the object's (airports, obstacles, etc) elevation, if known.

When the Map Pointer is placed on a map feature, the map feature is highlighted and an information box appears (even if the name was not originally displayed on the map).

Pressing the **ENT** Key displays a review page for the highlighted map feature. If multiple features are present at the Map Pointer position, a green arrow will appear in the information box. Turning the **FMS Joystick** will cycle through the list of map features present at that position.

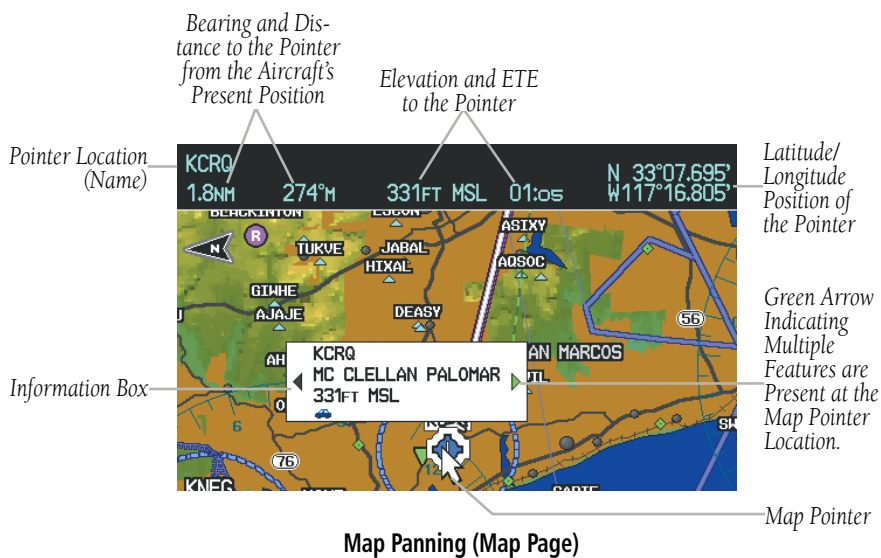

Panning the map:

- 1) Press the **FMS Joystick** (or **PAN MAP Softkey on the Weather (WX) Page**) to display the Map Pointer.
- 2) Move the **FMS Joystick** to move the Map Pointer around the map.
- 3) Press the **FMS Joystick** to remove the Map Pointer and re-center the map on the aircraft's current position.

Reviewing information for a map or weather feature:

- 1) Place the Map Pointer on a map feature. If multiple map features are present at the Map Pointer position (green arrow in the information box), turn the **FMS** Joystick to cycle through the list.
- 2) Press the **ENT** Key to display the review page for the highlighted feature.
- 3) Press the **FMS** Joystick, the **CLR** Key, or the **ENT** Key to exit the review page and return to the Map Page showing the selected waypoint.

MEASURING BEARING AND DISTANCE

Distance and bearing from the aircraft's present position to any point on the viewable navigation map may be calculated using the 'Measure Distance' selection from Map Page menu. The distance tool displays a dashed Measurement Line and a Map Pointer to aid in graphically identifying points to measure. Lat/Long, bearing, distance and elevation data for the Map Pointer is provided in a window at the top of the Map Page.

Measuring bearing and distance between any two points:

- 1) From the Map Page, press the **MENU** Key.
- 2) Turn or move the **FMS** Joystick to highlight the 'Measure Distance' field and press the **ENT** Key. A Measure Pointer is displayed on the map at the aircraft's present position.
- 3) Move the **FMS** Joystick to place the reference pointer at the desired location. The bearing and distance are displayed at the top of the map. Elevation at the current pointer position is also displayed. Pressing the **ENT** Key changes the starting point for measuring.
- 4) To exit the Measure Bearing/Distance option, press the **FMS** Joystick; or select 'Stop Measuring' from the Page Menu and press the **ENT** Key.

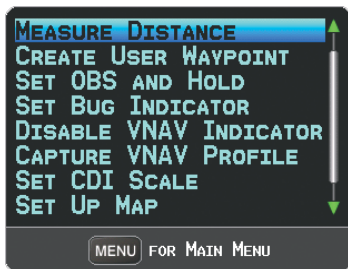

Map Page Menu

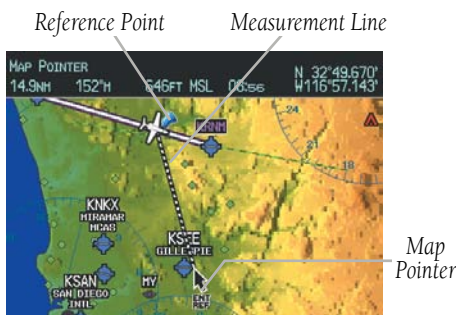

Map Page (Measure Distance)

TOPOGRAPHY

Topographic data can be displayed or removed as described in the following procedures.

Displaying/removing topographic data:

- 1) Press the **MAP** Softkey on the Map Page. Press the **VFR MAP** Softkey if necessary.
- 2) Press the **TOPO** Softkey. Topographic data is displayed.
- 3) Press the **TOPO** Softkey again to remove topographic data from the Navigation Map.

Or:

- 1) From the Map Page, press the **MENU** Key.
- 2) Turn or move the **FMS** Joystick to highlight 'Set Up Map', and press the **ENT** Key.
- 3) Turn the **FMS** Joystick to highlight the 'Map' Category from the horizontal list.
- 4) Move the **FMS** Joystick to highlight the 'Topo Shading' field.
- 5) Turn the **FMS** Joystick to select 'On' or 'Off', and press the **ENT** Key.



VFR MAP Softkey

TOPO Softkey

Topographic Data (Map Page)

SATELLITE VIEW

The Satellite View displays satellite imagery above 20nm.

Displaying/removing satellite imagery on the map page:

- 1) Press the **MAP** Softkey on the Map Page. Press the **VFR MAP** Softkey (if necessary).
- 2) Press the **SAT VIEW** Softkey. Satellite imagery is displayed on the map.
- 3) Press the **SAT VIEW** Softkey again to remove satellite imagery from the Navigation Map.

Or:

- 1) From the Map Page, press the **MENU** Key.
- 2) Turn or move the **FMS** Joystick to highlight 'Set Up Map', and press the **ENT** Key.
- 3) Turn the **FMS** Joystick to highlight the 'Map' Category from the horizontal list.
- 4) Move the **FMS** Joystick to highlight the 'Satellite View' field.
- 5) Turn the **FMS** Joystick to select 'On' or 'Off', and press the **ENT** Key.



VFR MAP Softkey

SAT VIEW Softkey

Satellite View (Map Page)

MAP SYMBOLS

Refer to Appendix G for a list of map symbols.

MAP DECLUTTER

The pilot can remove (declutter) unwanted items, such as highways from the map.

Decluttering the Map Page:

- 1) From any Map Page, press the **CLR** Key. 'CLEAR-1' appears below the map range. The background symbols (such as highways, cities, rivers, and smaller lakes) are removed from the map.
- 2) Press the **CLR** Key again. 'CLEAR-2' appears below the map range and airspace boundary detail is removed from the map.
- 3) Press the **CLR** Key again. 'CLEAR-3' appears below the map range. Only the waypoints and nav aids that are part of the current flight plan appear on the map.
- 4) Press the **CLR** Key again to return 'ALL' detail to the map.



Map Declutter

MAP DETAIL

The map detail can also be adjusted. Map detail changes the amount of detail with respect to the zoom scale.

Adjusting the map detail:

- 1) From the Map Page, press the **MENU** Key.
- 2) Turn or move the **FMS** Joystick to highlight 'Set Up Map', and press the **ENT** Key.
- 3) Turn the **FMS** Joystick to highlight the 'General' Category from the horizontal list.
- 4) Move the **FMS** Joystick to highlight the 'Detail Level' field.
- 5) Turn the **FMS** Joystick to select the desired detail level ('Most', 'More', 'Normal', 'Less', or 'Least'), and press the **ENT** Key.

AIRPORTS & NAVAIDS

Airport and NAVAID information can be customized to display a variety of information including: runway extension lines, runway numbers and visual reporting points (VRP).



Runway Extensions and Numbers (Map Page)

Setting up and customizing airports and NAVAIDs for the map page:

- 1) From the Map Page press the **MENU** Key.
- 2) Turn or move the **FMS** Joystick to highlight 'Set Up Map' and press the **ENT** Key.
- 3) Turn the **FMS** Joystick to select the 'Airport' or 'NAVAID' Category from the horizontal list.
- 4) Move the **FMS** Joystick to highlight the desired feature.
- 5) Turn the **FMS** Joystick to access a list of options for each feature (On/Off, Auto, range settings, or text size).
- 6) Using the **FMS** Joystick select the desired option and press the **ENT** Key.
- 7) Press the **FMS** Joystick, the **CLR** Key, or the **EXIT** Softkey to return to the Map Page with the changed settings.



Map Setup Page (Airport Category)

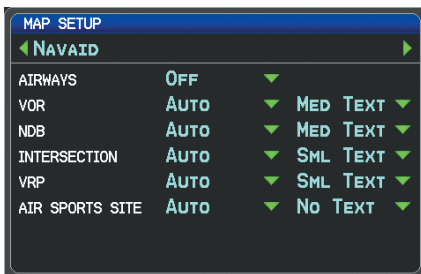

Map Setup Page (NAVAID Category)

CITIES & ROADS

Setting up and customizing cities and roads for the map page:

- 1) From the Map Page press the **MENU** Key.
- 2) Turn or move the **FMS** Joystick to highlight 'Set Up Map' and press the **ENT** Key.
- 3) Turn the **FMS** Joystick to select the 'City' or 'Road' Category from the horizontal list.
- 4) Move the **FMS** Joystick to highlight the desired feature.
- 5) Turn the **FMS** Joystick to access a list of options for each feature (On/Off, Auto, range settings, or text size).
- 6) Using the **FMS** Joystick select the desired option and press the **ENT** Key.
- 7) Press the **FMS** Joystick, the **CLR** Key, or the **EXIT** Softkey to return to the Map Page with the changed settings.



Map Setup Page (City Category)

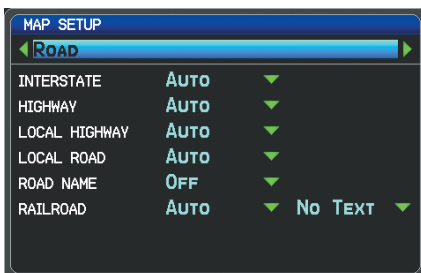

Map Setup Page (Road Category)

AIRSPACE

Setting up and customizing airspace for the map page:

- 1) From the Map Page press the **MENU** Key.
- 2) Turn or move the **FMS** Joystick to highlight 'Set Up Map' and press the **ENT** Key.
- 3) Turn the **FMS** Joystick to select the 'Airspace' or 'SUA' (Special Use Airspace) Category from the horizontal list.
- 4) Move the **FMS** Joystick to highlight the desired feature.
- 5) Turn the **FMS** Joystick to access a list of options for each feature (On/Off, Auto, or range settings).
- 6) Using the **FMS** Joystick select the desired option and press the **ENT** Key.
- 7) Press the **FMS** Joystick, the **CLR** Key, or the **EXIT** Softkey to return to the Map Page with the changed settings.

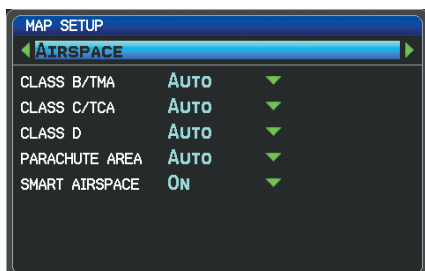

Map Setup Page (Airspace Category)

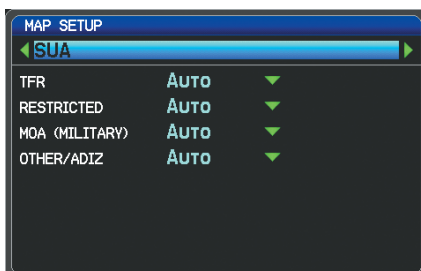

Map Setup Page (SUA Category)

AIRWAYS

Low Altitude Airways (or Victor Airways) primarily serve smaller piston-engine, propeller-driven airplanes on shorter routes and at lower altitudes. Airways are eight nautical miles wide and start 1,200 feet above ground level (AGL) and extend up to but not including 18,000 feet mean sea level (MSL). Low Altitude Airways are designated with a "V" before the airway number (hence the name "Victor Airways") since they run primarily between VORs.

High Altitude Airways (or Jet Routes) primarily serve airliners, jets, turboprops, and turbocharged piston aircraft operating above 18,000 feet MSL. Jet Routes start at 18,000 feet MSL and extend upward to 45,000 feet MSL (altitudes above 18,000 feet

are called “flight levels” and are described as FL450 for 45,000 feet MSL). Jet Routes are designated with a “J” before the route number.

Low Altitude Airways are drawn in gray. High Altitude Airways are drawn in green. When both types of airways are displayed, high altitude airways are drawn on top of Low Altitude Airways.

When airways are selected for display on the map, the airway waypoints (VORs, NDBs, and Intersections) are also displayed.

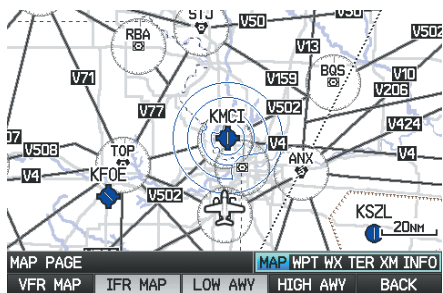

IFR Map - Low Airways
(Victor Airways)



IFR Map - High Airways
(Jet Routes)

Airways may be displayed on the map at the pilot’s discretion using the **MAP** Softkey on the Map Page.

Displaying/removing airways:

- 1) Select the **MAP** Softkey on the Map Page.
- 2) Select the **IFR MAP** Softkey to display the IFR Map and related softkeys.
- 3) Select/deselect the **LOW AWY** Softkey to display/remove the Low Altitude Airways.
- 4) Select/deselect the **HIGH AWY** Softkey to display/remove the High Altitude Airways.
- 5) Press the **BACK** Softkey to return to the top-level softkeys.

Reviewing information for an airway:

- 1) From the Map Page, press the **MAP** Softkey.
- 2) Press the **IFR MAP** Softkey (if necessary).
- 3) With the **LOW AWY** and/or **HIGH AWY** Softkeys selected, press the **FMS** Joystick to display the Map Pointer.

- Place the Map Pointer on an airway. The MEA, name of airway, endpoints, distance, and calculated radials are displayed.

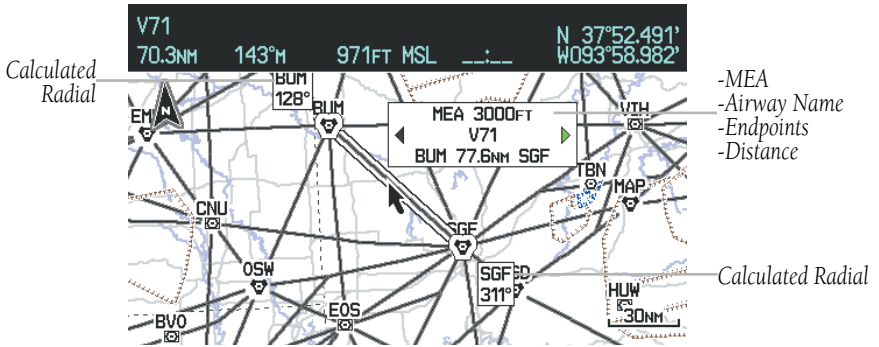

Reviewing Airway Information (Map Page)

- Press the **ENT** Key to display the review page for the airway.

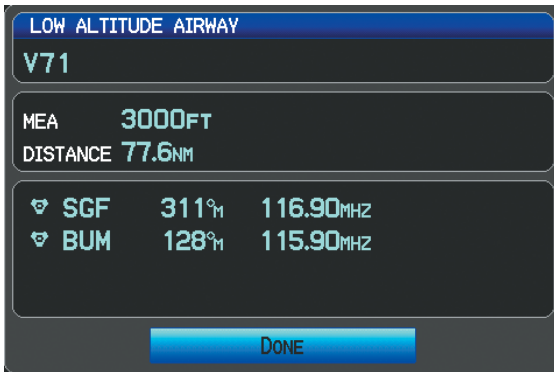

Low Altitude Airway Review Page

- Press the **FMS** Joystick, the **CLR** Key, or the **ENT** Key to exit the review page and return to the Map Page.

2.5 WAYPOINTS

The Waypoint (WPT) Page provides airport and waypoint information.

Waypoints are predetermined geographical positions (internal database) or pilot-entered positions, and are used for all phases of flight planning and navigation.

Waypoints can be selected by entering the ICAO identifier, entering the name of the facility, or by entering the city name. As a waypoint identifier, facility name, or location is entered, the GPSMAP 695/696's Spell'N'Find feature scrolls through the database, displaying those waypoints matching the characters which have been entered up to that point. A direct-to navigation leg to the selected waypoint can be initiated by pressing the Direct-to Key from the Waypoint Page.

The Waypoint Page allows the pilot to review airport information, runway information, frequencies, instrument procedures, Airport Directory information, and weather information. The pilot can manually enter the identifier or the GPSMAP 695/696 will choose the most appropriate identifier based on the current position and phase of flight.

The following descriptions and abbreviations are used:

- Usage type: Public, Military, or Private
- Runway surface type: Hard, Turf, Sealed, Gravel, Dirt, Soft, Unknown, or Water
- Runway lighting type: No Lights, Part Time, Full Time, Unknown, or PCL Freq (for pilot-controlled lighting)
- COM Availability: TX (transmit only), RX (receive only), PT (part time), * (additional information available)

-Waypoint Identifier/Symbol/Type
-Facility Name
-City/Region

-Region
-Country

Map Showing Selected Waypoint

Airport Information
-Elevation
-Fuel Available
-Time Zone
-UTC Offset
-Daylight Savings Time
-Lat/Long
-Bearing/Distance

Runway Information
-Designation
-Length/Width
-Surface
-Lighting
-Displaced Threshold Distance
-Traffic Pattern
-Wind Speed/Direction

COM/NAV Freq. Info.
-Identification
-Frequency
-Availability
-Additional Information

INFO Softkey Selected

Waypoint Page (INFO Softkey Selected)

Selecting an airport for review by identifier, facility name, or location:

- 1) From the Waypoint (WPT) Page, press the **INFO** Softkey.
- 2) Press the **FMS** Joystick to activate the cursor.
- 3) Turn the **FMS** Joystick clockwise to begin entering a waypoint identifier (turning it counter-clockwise brings up the waypoint selection submenu - press the **CLR** Key to remove it), or move the **FMS** Joystick to select the facility name, or city field.
- 4) Press the **ENT** Key.

If duplicate entries exist for the entered facility name or location, additional entries may be viewed by continuing to turn the **FMS** Joystick during the selection process. If duplicate entries exist for an identifier, a Duplicate Waypoints Window is displayed. Press the **ENT** Key to move the cursor to the Duplicate Waypoints Window.

Duplicate
Waypoints
Window

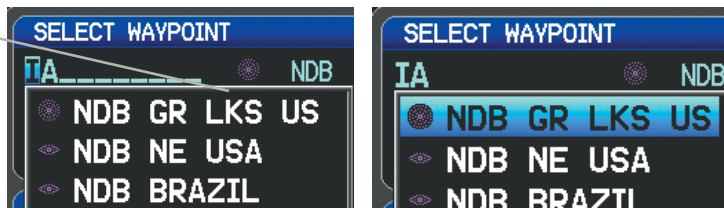

Waypoint Information Window-Duplicate Identifier

Selecting a runway:

- 1) With the Waypoint (WPT) Page displayed, press the **INFO** Softkey.
- 2) Press the **FMS** Joystick to activate the cursor.
- 3) Turn the **FMS** Joystick clockwise to begin entering a waypoint identifier for the desired runway (turning it counter-clockwise brings up the waypoint selection submenu - press the **CLR** Key to remove it), or move the **FMS** Joystick to select the facility name, or city field.
- 4) Press the **ENT** Key.
- 5) Move the **FMS** Joystick to place the cursor in the 'Runways' Box, on the runway designator.



Runways Box (Waypoint Page)

- 6) Turn the **FMS** Joystick to display the desired runway (if more than one) for the selected airport.

FREQUENCIES

The Frequencies Box uses the descriptions and abbreviations listed in the following table:

Communication Frequencies			Navigation Frequencies
Approach *	Control	Pre-Taxi	ILS
Arrival *	CTA *	Radar	LOC
ASOS	Departure *	Ramp	
ATIS	Gate	Terminal*	
AWOS	Ground	TMA *	
Center	Helicopter	Tower	
Class B *	Multicom	TRSA *	
Class C *	Other	Unicom	
Clearance			
* May include Additional Information			

Frequency Abbreviations

The frequencies may be denoted by 'RX', 'TX', or 'CTAF' if applicable.

Viewing additional information for a frequency:

- 1) With the Waypoint (WPT) Page displayed, press the **INFO** Softkey.
- 2) Press the **FMS** Joystick to activate the cursor.
- 3) Move the **FMS** Joystick to place the cursor in the 'Frequencies' Box, on the frequency denoted with an *.

FREQUENCIES		
ATIS	RX	135.400
PRE-TAXI		121.600
PRE-TAXI	*	119.250
CLEARANCE		121.600
CLEARANCE	*	119.250
GATE		129.050
GROUND		121.675

Additional Frequency Information (Waypoint Page)

- 4) Press the **ENT** Key to view the Additional Information Window.
- 5) To remove the window, press the **FMS** Joystick, **ENT** Key, or **CLR** Key.

To quickly view the departure or destination airport information:

- 1) From the Waypoint (WPT) Page, press the **INFO**, **CHART**, **AOPA**, or **WEATHER** Softkey.
- 2) Press the **MENU** Key.
- 3) Turn or move the **FMS** Joystick to highlight 'View Destination Airport' or 'View Departure Airport', and press the **ENT** Key.

NEAREST INFORMATION

The GPSMAP 695/696 provides a **NRST** Key which gives the pilot quick access to nearest airport, weather, VOR, NDB, intersection, user waypoint, city, ARTCC, FSS, and airspace information. If there are none available, "None Within 200 NM" is displayed.

Pressing the **ENT** Key displays the associated 'Information Page' for the highlighted selection, similar to the Waypoint Page. Pressing the **ENT** Key again returns to the Nearest Page.

Viewing nearest information:

- 1) Press the **NRST** Key.
- 2) Turn the **FMS** Joystick to select the desired Nearest Page (APT, WX, VOR, NDB, INT, USR, CTY, ATC, FSS, or ASPC). If none are available, "None Within 200 NM" is displayed.
Or: Press the **NRST** Key again to quickly select the nearest airport.
- 3) Press the **FMS** Joystick to highlight the first selection in the list. Turn or move the **FMS** Joystick to highlight the desired nearest option.
- 4) Press the **ENT** Key to display the associated 'Information Page'. From the Airport Information Page and Weather Information Page, press the **INFO**, **CHART**, **AOPA / DIRECTORY**, or **WEATHER** Softkeys for additional information. From the User Waypoint Information Page, press the **DELETE** or **EDIT** softkeys to make changes to the selected user waypoint.
- 5) To return to the Nearest Page, press the **FMS** Joystick, the **ENT** Key, or the **CLR** Key.



Nearest Airports Page



Airport Information Page

NEAREST AIRPORT CRITERIA

From the Menu on the Nearest Airports Page the pilot can define the minimum runway length and surface type used when determining the 15 nearest airports to display on the Nearest Airports Page. A minimum runway length and/or surface type can be entered to prevent airports with small runways or runways that are not appropriately surfaced from being displayed. Default settings are 0 feet (or meters) for runway length and "Any" for runway surface type. Private airports and Heliports can also be included.

The Page Menu also allows the pilot to choose between displaying the facility names, city names, bearing, or direction arrows.

To quickly show/hide private airport and heliports from the Nearest Airports Page, press the **PRIVATE** or **HELIPORT** Softkeys.

Setting nearest airport criteria:

- 1) With the Nearest Airports Page displayed, press the **MENU** Key.
- 2) Turn or move the **FMS** Joystick to select 'Set Airport Criteria' from the Page Menu.

- 3) Press the **ENT** Key. The Airport Criteria Window is displayed.
- 4) Move the **FMS** Joystick to select the desired criteria to be defined.
- 5) Turn the **FMS** Joystick to select the desired option.
- 6) Press the **ENT** Key.



Nearest Airports Page Menu

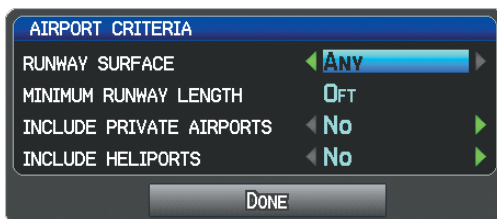

Airport Criteria Window

Restoring nearest airport criteria defaults:

- 1) With the Nearest Airports Page displayed, press the **MENU** Key.
- 2) Turn or move the **FMS** Joystick to select 'Set Airport Criteria' from the Page Menu.
- 3) Press the **ENT** Key. The Airport Criteria Window is displayed.
- 4) Press the **MENU** Key.
- 5) With 'Restore Default' highlighted, press the **ENT** Key.

WEATHER INFORMATION

Textual weather information can be viewed from the Waypoint Page or the Nearest WX Page. Refer to the Hazard Avoidance section for information on SiriusXM Weather and FIS-B.

Selecting airport weather information:

- 1) From the Waypoint Page, press the **WEATHER** Softkey.
- 2) Press the **FMS** Joystick to activate the cursor.
- 3) Turn the **FMS** Joystick clockwise to begin entering an airport identifier (turning it counter-clockwise brings up the waypoint selection submenu - press the **CLR** Key to remove it).
- 4) Press the **ENT** Key.

Or:

- 1) Press the **NRST** Key.
- 2) Turn the **FMS** Joystick to select the Nearest Airport WX Page. If Nearest Airport Weather is not available, "None Within 200 NM" is displayed.
- 3) Press the **NRST** Key again or press the **FMS** Joystick to highlight the first airport in the nearest airport weather list. Turn or move the **FMS** Joystick to highlight the desired airport weather.
- 4) Press the **ENT** Key to display the Weather Information Page.
- 5) Turn the **FMS** Joystick to scroll up or down on the page.
- 6) To return to the Nearest Airport Weather Page, press the **FMS** Joystick, the **ENT** Key, or the **CLR** Key.



Nearest Airport Weather Page



Weather Information Page

INTERSECTIONS

Intersections can be viewed from the Waypoint Page or the Nearest Intersections Page. In addition to displaying a map of the currently selected intersection and surrounding area, the Intersection Information Page displays the region, bearing, distance, latitude, and longitude.

Select an intersection:

- 1) From the Waypoint Page, press the **INFO** Softkey.
- 2) Press the **FMS** Joystick to activate the cursor.
- 3) Turn the **FMS** Joystick clockwise to begin entering an intersection identifier (turning it counter-clockwise brings up the waypoint selection submenu - press the **CLR** Key to remove it), or move the **FMS** Joystick to select the facility name, or city field.
- 4) Press the **ENT** Key.

Or:

- 1) Press the **NRST** Key.
- 2) Turn the **FMS** Joystick to select the Nearest Intersections Page.
- 3) Press the **FMS** Joystick to activate the cursor.
- 4) Turn or move the **FMS** Joystick to highlight the desired intersection.
- 5) Press the **ENT** Key to display the Intersection Information Page.

NDBs

NDBs can be viewed from the Waypoint Page or the Nearest NDBs Page. In addition to displaying a map of the currently selected NDB and surrounding area, the page displays the region, bearing, distance, latitude, longitude and frequency.

The Nearest NDB Page can be used to quickly find a NDB close to the flight path. The list only includes NDBs that are within 200nm. If there are no NDBs in the list, text indicating that there are no nearest NDBs is displayed. If there are no nearest NDBs in the list, the information and frequency fields are dashed.

Select an NDB:

- 1) From the Waypoint Page, press the **INFO** Softkey if necessary.
- 2) Press the **FMS** Joystick to activate the cursor.

- 3) Turn the **FMS** Joystick clockwise to begin entering the identifier (turning it counter-clockwise brings up the waypoint selection submenu - press the **CLR** Key to remove it), or move the **FMS** Joystick to select the facility name, or city field.
- 4) Press the **ENT** Key.
Or:
 - 1) Press the **NRST** Key.
 - 2) Turn the **FMS** Joystick to select the Nearest NDBs Page.
 - 3) Press the **FMS** Joystick to activate the cursor.
 - 4) Turn the **FMS** Joystick to highlight the desired NDB.
 - 5) Press the **ENT** Key to display the NDB Information Page.

VORS

VORs can be viewed from the Waypoint Page or the Nearest NDBs Page. In addition to displaying a map of the currently selected VOR and surrounding area, the page displays the region, city, state, bearing, distance, latitude, longitude, frequency and class (High, Low, or Terminal VOR).

The Nearest VOR Page can be used to quickly find a VOR close to the flight path. The list only includes VORs that are within 200nm. If there are no VORs in the list, text indicating that there are no nearest VORs is displayed. If there are no nearest VORs in the list, the information and frequency fields are dashed.

Localizer information cannot be viewed on the VOR Information Page. If a VOR station is combined with a TACAN station it is listed as a VORTAC on the VOR Information Page and if it includes only DME, it's displayed as VOR-DME.

Select an VOR:

- 1) From the Waypoint Page, press the **INFO** Softkey.
- 2) Press the **FMS** Joystick to activate the cursor.
- 3) Turn the **FMS** Joystick clockwise to begin entering identifier (turning it counter-clockwise brings up the waypoint selection submenu - press the **CLR** Key to remove it), or move the FMS Joystick to select the facility name, or city field.
- 4) Press the **ENT** Key.

Or:

- 1) Press the **NRST** Key.
- 2) Turn the **FMS** Joystick to select the Nearest VOR Page.
- 3) Press the **FMS** Joystick to activate the cursor.
- 4) Turn the **FMS** Joystick to highlight the desired VOR.
- 5) Press the **ENT** Key to display the VOR Information Page.

USER WAYPOINTS

The GPSMAP 695/696 can create and store up to 3,000 user-defined waypoints. Once a waypoint has been created, it can be renamed, deleted, or moved.

Creating user waypoints:

- 1) To create a user waypoint at the current location, using the Map Pointer, or from the Main Menu:
 - a) To create a user waypoint at the current location, press and hold the **ENT** Key from any page.
 - b) The 'Mark a New User Waypoint?' window appears.
- Or:
- a) Press the **MENU** Key twice to access the Main Menu.
 - b) Move the **FMS** Joystick to highlight 'User Waypoints' and press the **ENT** Key.



Main Menu (User Waypoints Selected)

- c) Press the **NEW** Softkey. The message "Create a New User Waypoint?" message is displayed. The current aircraft position is the default location of the new waypoint.

Or:

a) From a map page, press the **FMS** Joystick to activate the Map Pointer (on the WX Page, press the **PAN MAP** Softkey or press **Menu**, then 'Show Map Point').

b) Find an empty area without any map features and press the **ENT** Key. The message "Create a New User Waypoint?" message is displayed.

Or:

a) From a map page, press the **FMS** Joystick to activate the Map Pointer (on the WX Page, press the **PAN MAP** Softkey) ('Create User Waypoint' is not available in the WX Page Menu).

b) Select a map feature using the Map Pointer and press the **MENU** Key.

c) With 'Create User Waypoint' highlighted, press the **ENT** Key. The message "Create a New User Waypoint?" message is displayed.

2) With 'Yes' highlighted, press the **ENT** Key. The New Waypoint Window is displayed.

3) Move the **FMS** Joystick to the User Waypoint Name Field and enter the waypoint name, if desired.

4) If desired, select the waypoint symbol:

a) Move the **FMS** Joystick to highlight the Symbol.

b) Turn the **FMS** Joystick to access the 'Select Symbol' Menu.

c) Turn or move the **FMS** Joystick to highlight the desired symbol from the menu, and press the **ENT** Key.

Symbol Field (Selected) User Waypoint Name Field



New Waypoint Window (Symbol Selected)

- 5) If desired, press the **POSITION** Softkey and enter the latitude, longitude, name, or altitude for the waypoint **or** press the **REF WPTS** Softkey to enter a bearing and distance from another waypoint or the bearing from two other waypoints to define the new waypoint location.

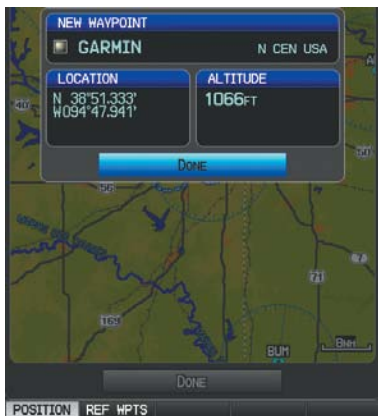

**New Waypoint Window
(POSITION Softkey Selected)**

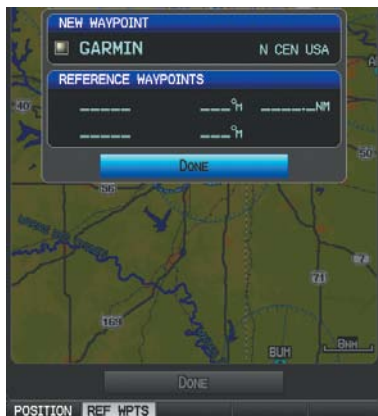

**New Waypoint Window
(REF WPTS Softkey Selected)**

- 6) With 'Done' highlighted, press the **ENT** Key.

Selecting and viewing nearest user waypoints:

- 1) Press the **NRST** Key.
- 2) Turn the **FMS** Joystick to select the Nearest USR Page.
- 3) Press the **FMS** Joystick to activate the cursor.
- 4) Turn the **FMS** Joystick to highlight the desired user waypoint.
- 5) Press the **ENT** Key to display the User Waypoint Information Window.

Editing or renaming a user waypoint:

- 1) Press the **MENU** Key twice to access the Main Menu.
- 2) Move the **FMS** Joystick to highlight 'User Waypoints' and press the **ENT** Key.
- 3) Move the **FMS** Joystick to highlight the appropriate waypoint and press the **EDIT** Softkey. The Edit Waypoint Window is displayed.
- 4) Move the cursor to the desired field(s) and make any necessary changes (to edit the Reference Waypoints, press the **REF WPTS** Softkey).
- 5) With 'Done' highlighted, press the **ENT** Key.

Deleting user waypoints:

- 1) Press the **MENU** Key twice to access the Main Menu.
- 2) Turn or Move the **FMS** Joystick to highlight 'User Waypoints' and press the **ENT** Key. If deleting all user waypoints, go to Step 4.
- 3) Highlight a User Waypoint in the User Waypoint List, or enter a waypoint in the User Waypoint field.
- 4) Press the **MENU** Key.



User Waypoints Page Menu

- 5) Select 'Delete Waypoint' or 'Delete All'.
- 6) Press the **ENT** Key. 'No' is highlighted in the confirmation window.
- 7) With 'Yes' highlighted in the confirmation window, press the **ENT** Key.

Or:

- 1) Press the **MENU** Key twice to access the Main Menu.
- 2) Turn or Move the **FMS** Joystick to highlight 'User Waypoints' and press the **ENT** Key.
- 3) Highlight a User Waypoint in the User Waypoint List, or enter a waypoint in the User Waypoint field.
- 4) Press the **ENT** Key.
- 5) Press the **DELETE** Softkey. 'No' is highlighted in the confirmation window.
- 6) Highlight 'Yes' and press the **ENT** Key.

User Waypoints can also be deleted by 'Symbol' or 'Distance' from the User Waypoints Page Menu.

2.6 AIRSPACE

The GPSMAP 695/696 can display the following types of airspaces: Class B/TMA, Class C/TCA, Class D, Restricted, MOA (Military), Other Airspace, Air Defense Identification Zone (ADIZ), and Temporary Flight Restriction (TFR), and Parachute Jump Areas.

The Nearest Airspace Page and Airspace Alerts provide information about airspaces and the location of the aircraft in relationship to them. The Nearest Airspace Page can be used to quickly find airspaces close to the flight path.

The Nearest Airspace Page displays the class of airspace, controlling agency, vertical boundaries, and status.

Selecting and viewing nearest airspaces:

- 1) Press the **NRST** Key.
- 2) Turn the **FMS** Joystick to select the Nearest Airspace Page.
- 3) Press the **FMS** Joystick to highlight the nearest airspace. Turn or move the **FMS** Joystick to highlight the desired airspace.
- 4) Press the **ENT** Key to display the Airspace Information Page.
- 5) Press the **FREQS** Softkey (if available) to display frequency and additional airport information similar to the Waypoint Information Page.

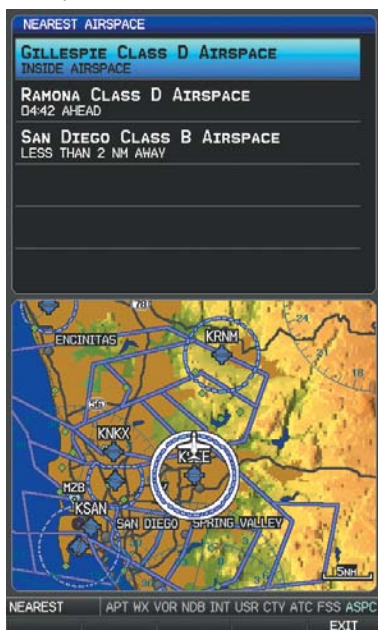

Nearest Airspace Page

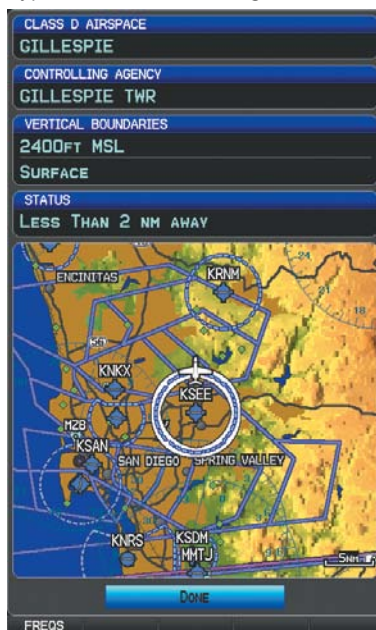

Airspace Information Page

AIRSPACE ALERT MESSAGES

When an airspace alert appears, press the **NRST** Key to automatically show nearby airspace information on the Nearest Airspace Page. This information includes name, time to entry (if applicable), and status.

There are four types of status information:

- Ahead—Projected to enter the airspace within the next 10 minutes or less.
- Near—Within two nautical miles of an airspace but not projected to enter it.
- Near & Ahead—Project to enter the airspace within two nautical miles.
- Inside Airspace—Within the boundaries of the airspace.

SMART AIRSPACE™

Smart Airspace™ shows airspace at and immediately surrounding the aircraft's current altitude in bold. Airspaces at all other altitudes are de-emphasized.



Smart Airspace™

2.7 DIRECT-TO NAVIGATION

The Direct-to method of navigation, initiated by pressing the Direct to Key is quicker to use than a flight plan when the desire is to navigate to a single point such as a nearby airport.

Once a direct-to is activated, the GPSMAP 695/696 establishes a point-to-point course line from the present position to the selected direct-to destination. Course guidance is provided until the direct-to is replaced with a new direct-to or flight plan, or cancelled.

Entering a waypoint identifier, facility name, or city as a direct-to destination:

- 1) Press the **Direct-to** Key. The Direct-to Window is displayed (with the active flight plan waypoint as the default selection or a blank waypoint field if no flight plan is active).
- 2) Turn the **FMS** Joystick clockwise to begin entering a waypoint identifier (turning it counter-clockwise brings up the waypoint selection submenu - press the **CLR** Key to remove it), press the **RECENT** Softkey to display a list of recent waypoints, or move the **FMS** Joystick to select the facility name, or city field.
- 3) Press the **ENT** Key.
- 4) With 'Activate' highlighted, press the **ENT** Key.



Direct-to Window

Selecting RECENT WPTS, NRST APTS, or FPL WPTS as a direct-to destination:

- 1) Press the **Direct-to** Key. The Direct-to Window is displayed (with the active flight plan destination as the default selection or a blank destination if no flight plan is active).
- 2) Press the **RECENT** Softkey to display a list of recent waypoints (RECENT WPTS) only or turn the **FMS** Joystick counter-clockwise to display a list of recent waypoints (RECENT WPTS), nearest airports (NRST APTS), and flight plan waypoints (FPL WPTS).
- 3) Move the **FMS** Joystick to select the desired waypoint.
- 4) Press the **ENT** Key.
- 5) With 'Activate' highlighted, press the **ENT** Key.



Flight Plan Waypoints (Direct-to Window)

Selecting a nearby airport as a direct-to destination:

- 1) Press the **NRST** Key.
- 2) Select the desired airport (the nearest one is already selected).
- 3) Press the **Direct-to** Key.
- 4) Press the **ENT** Key.
- 5) With 'Activate' highlighted, press the **ENT** Key.

Direct-to destinations may also be selected by using the pointer on the navigation map pages. If no airport, NAVAID, or user waypoint exists at the desired location, a temporary waypoint named 'MAP POINTER' is automatically created at the location of the map arrow.

Selecting a waypoint as a direct-to destination using the pointer:

- 1) From a navigation map page, press the **FMS** Joystick to display the pointer.
- 2) Move the **FMS** Joystick to place the pointer at the desired destination location.
- 3) If the pointer is placed on an existing airport, NAVAID, or user waypoint, the waypoint name is highlighted.
- 4) Press the **Direct-to** Key to display the Direct-to Window with the selected point entered as the direct-to destination.
- 5) Press the **ENT** Key.
- 6) With 'Activate' highlighted, press the **ENT** Key.

Cancelling a direct-to:

- 1) Press the **Direct-to** Key to display the Direct-to Window.
- 2) Move the **FMS** Joystick to highlight 'Stop Navigation' or 'Resume Flight Plan' if a flight plan was active.
- 3) Press the **ENT** Key. If a flight plan is still active, the GPSMAP 695/696 resumes navigating the flight plan along the closest leg.

SECTION 3 FLIGHT PLANNING

3.1 INTRODUCTION

Flight planning on the GPSMAP 695/696 consists of building a flight plan by entering waypoints one at a time and inserting approaches as needed. The flight plan is displayed on maps using different line widths, colors, and types, based on the type of leg and the segment of the flight plan currently being flown.

Up to 50 flight plans with up to 300 waypoints each can be created and stored in memory. One flight plan can be activated at a time and becomes the active flight plan. The active flight plan is erased when the destination is reached and the system is turned off. When storing flight plans with an approach, the GPSMAP 695/696 uses the waypoint information from the current database to define the waypoints. If the database is changed or updated, the GPSMAP 695/696 automatically updates the information if the procedure has not been modified. If an approach is no longer available, the procedure is deleted from the affected stored flight plan(s), and an alert is displayed.

Whenever an approach is loaded into the active flight plan it replaces the destination airport with a sequence of waypoints for the selected approach. The airport must have a published instrument approach and only the final course segment (usually from final approach fix to missed approach point) of the published approach is available in the GPSMAP 695/696.

DATA FIELDS

By default, the Data Fields on the Active and Saved Flight Plan Pages are set to display Leg Desired Track (LEG DTK), Leg Distance (LEG DIS), and Leg Estimated Time En Route (LEG ETE) or Leg Estimate Safe Altitude (LEG ESA) for a Saved Flight Plan. The first two Data Fields can be changed using the Page Menu. The last Data Field can be changed using the **FMS** Joystick.

Changing the information shown in the data fields:

From the Active Flight Plan Page or the Saved Flight Plan Page, move the **FMS** Joystick (right or left) to quickly change the third data field.

Or:

- 1) From the Active Flight Plan Page or the Saved Flight Plan Page, press the **MENU** Key.
- 2) Turn or move the **FMS** Joystick to highlight 'Change Data Fields' and press the **ENT** Key. The cursor is displayed on the first Data Field.
- 3) If desired, move the **FMS** Joystick to highlight the second Data Field.
- 4) Turn the **FMS** Joystick to access the list of available Data Fields.
- 5) Turn or Move the **FMS** Joystick to highlight the desired option from the list and press the **ENT** Key.

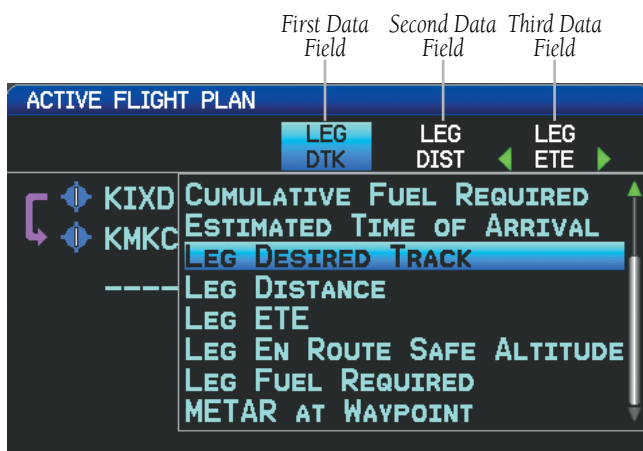

Data Field Selection (Active Flight Plan Page)

3.2 FLIGHT PLAN CREATION

The active flight plan is listed on the Active Flight Plan Page. It is the flight plan to which the GPSMAP 695/696 is currently providing guidance, and is shown on the navigation maps. Stored flight plans are listed on the Flight Plan List Page, and are available for activation (becomes the active flight plan).

The Data Fields in the third column of the Active and Saved Flight Plan Pages can be scrolled through by moving the **FMS** Joystick left or right. All other Data Fields can be changed through the 'Change Data Fields' option of the Page Menu.

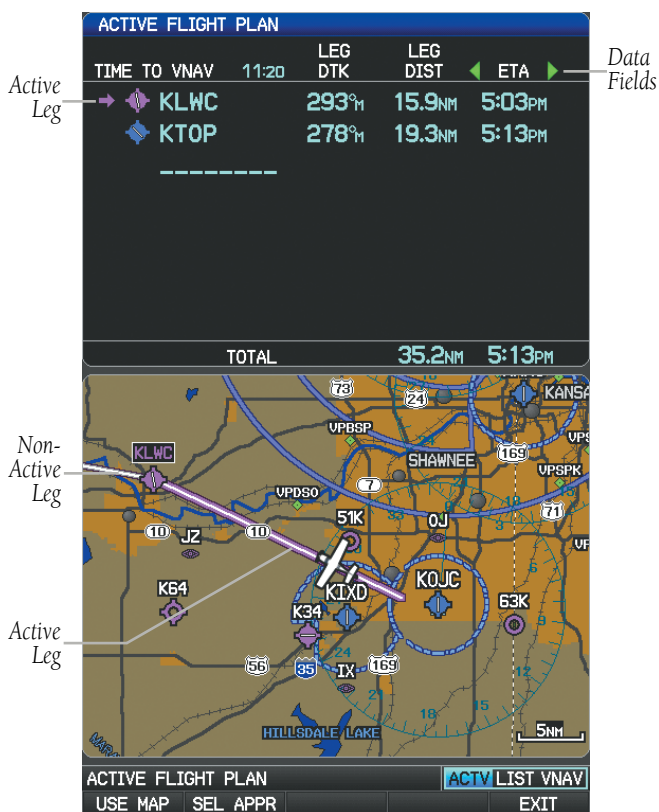

Active Flight Plan Page

Creating an active flight plan:

- 1) Press the **FPL** Key.
- 2) Press the **FMS** Joystick to activate the cursor.
- 3) Turn the **FMS** Joystick to display the Insert Waypoint Window. (Turning it clockwise displays a blank Insert Waypoint Window, turning it counter-clockwise displays a list of recent waypoints (RECENT WPTS), nearest airports (NRST APTS), or flight plan waypoints (FPL WPTS)).

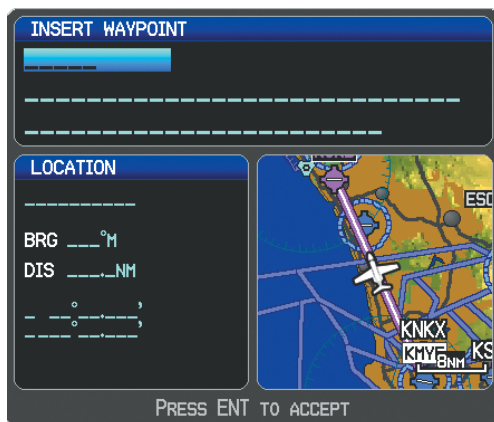

Insert Waypoint Window

- 4) Enter the identifier, facility, or city name of the departure waypoint or select a waypoint from the submenu of waypoints and press the **ENT** Key. The active flight plan is modified as each waypoint is entered.
- 5) Repeat step numbers 3 and 4 to enter each additional flight plan waypoint.
- 6) When all waypoints have been entered, press the **FMS** Joystick to remove the cursor.

Creating a stored flight plan:

- 1) Press the **FPL** Key.
- 2) Turn the **FMS** Joystick to display the Flight Plan List Page.
- 3) Press the **NEW** Softkey; or press the **MENU** Key, highlight 'New Flight Plan', and press the **ENT** Key to display a blank flight plan for the first empty storage location.
- 4) Turn the **FMS** Joystick to display the Insert Waypoint Window (turning it clockwise displays a blank Insert Waypoint Window, turning it counter-clockwise displays the a list of recent waypoints (RECENT WPTS), nearest airports (NRST APTS), or flight plan waypoints (FPL WPTS)).

- 5) Enter the identifier, facility, or city name of the departure waypoint or select a waypoint from the submenu of waypoints and press the **ENT** Key.
- 6) Repeat steps 4 and 5 to enter each additional flight plan waypoint.
- 7) When all waypoints have been entered, press the **FMS** Joystick to return to the Flight Plan List Page. The new flight plan is now in the list.

ADDING WAYPOINTS TO AN EXISTING FLIGHT PLAN

Waypoints can be added to the active flight plan or any stored flight plan. Choose the flight plan, select the desired point of insertion, enter the waypoint, and it is added in front of the selected waypoint. Flight plans are limited to 300 waypoints (including approach waypoints).

Adding a waypoint to a stored flight plan:

- 1) On the Flight Plan List Page, press the **FMS** Joystick to activate the cursor.
- 2) Turn or move the **FMS** Joystick to highlight the desired flight plan.
- 3) Press the **ENT** Key.
- 4) Move the **FMS** Joystick to select the point in the flight plan to add the new waypoint. The new waypoint is placed directly in front of the highlighted waypoint.
- 5) Enter the new waypoint by one of the following:
 - a) Turn the **FMS** Joystick clockwise to display a blank Insert Waypoint Window.
 - b) Using the **FMS** Joystick enter the identifier, facility, or city name of the desired waypoint.
 - c) Press the **ENT** Key.

Or:

 - a) Turn the **FMS** Joystick clockwise to display a blank Insert Waypoint Window.
 - b) Turn the **FMS** Joystick counter-clockwise to display a list of recent waypoints (RECENT WPTS), nearest airports (NRST APTS), or flight plan waypoints (FPL WPTS)).
 - c) Select the desired waypoint from the submenu.
 - d) Press the **ENT** Key.

Or:

- a) Turn the **FMS** Joystick counter-clockwise to display a list of recent waypoints (RECENT WPTS), or nearest airports (NRST APTS).
- c) Select the desired waypoint from the submenu.
- d) Press the **ENT** Key.

Adding a waypoint to the active flight plan:

- 1) Press the **FPL** Key.
- 2) Press the **FMS** Joystick to activate the cursor.
- 3) Using the **FMS** Joystick select the point in the flight plan before which to add the new waypoint. The new waypoint is placed directly in front of the highlighted waypoint.
- 4) Turn the **FMS** Joystick to display the Insert Waypoint Window (Turning it clockwise displays a blank Insert Waypoint Window, turning it counter-clockwise displays the a list of recent waypoints (RECENT WPTS), nearest airports (NRST APTS), or flight plan waypoints (FPL WPTS)).
- 5) Enter the identifier, facility, or city name of the departure waypoint or select a waypoint from the submenu of waypoints and press the **ENT** Key. The active flight plan is modified as each waypoint is entered.

Loading an approach procedure into a stored flight plan:

An Approach Procedure can be loaded at any airport that has an approach available. Only one approach can be loaded at a time in a flight plan. The route for a selected approach is defined by designating transition waypoints.

- 1) Press the **FPL** Key.
- 2) Turn the **FMS** Joystick to select the Flight Plan List Page.
- 3) Press the **FMS** Joystick to activate the cursor.
- 4) Turn or move the **FMS** Joystick to highlight the desired flight plan and press the **ENT** Key.
- 5) Press the **SEL APPR** Softkey.
- 6) Turn the **FMS** Joystick to display a drop down list of available approaches.
- 7) Turn or move the **FMS** Joystick to highlight the desired approach and press the **ENT** Key.
- 8) With 'Select Approach' highlighted, press the **ENT** Key.

GRAPHICAL FLIGHT PLANNING

Flight Plans can be created and edited on the GPSMAP 695/696 by using the Map Area and the FMS Joystick.

Graphical Flight Plan Creation:

- 1) Press the **FPL** Key.
- 2) From the Active Flight Plan Page or from the Flight Plan List Page after pressing the **NEW** Softkey, press the **USE MAP** Softkey to activate the map pointer.

Or: Press the **MENU** Key and select 'Edit on Map'.

- 3) Use the **FMS** Joystick to move the map pointer and rubber band to the desired point on the map.



NOTE: If the selected map point is a database map feature, its name is inserted into the Active Flight Plan. If the selected map point is not a database map feature, a user waypoint may be created and inserted into the Flight Plan.

- 4) With the desired waypoint selected press the **ENT** Key. The waypoint is added to the flight plan and the **APPEND** Softkey is selected. To view information about a waypoint without adding it to the flight plan, deselect the **APPEND** Softkey and press the **ENT** Key



Graphical Flight Plan Window

- 5) With the **APPEND** Softkey selected, repeat step numbers 3 and 4 to enter each additional flight plan waypoint.
- 6) Press the **DONE** Softkey (from the Saved Flight Plan Page only)

Adding Flight Plan Waypoints Graphically:

- 1) Press the **FPL** Key.
- 2) From the Active Flight Plan Page or from the Saved Flight Plan Page, press the **USE MAP** Softkey to activate the map pointer.
Or: Press the **MENU** Key and select 'Edit on Map'.
- 3) Press the **APPEND** softkey to display the rubber band. (The new waypoint is inserted at the end of the flight plan. To add a waypoint between existing flight plan waypoints see Graphical Flight Plan Editing).
- 4) Move the **FMS** Joystick to highlight the desired waypoint to be added to the Flight Plan and press the **ENT** Key. The new waypoint is appended to the Active or Saved Flight Plan.

Removing Flight Plan Waypoints Graphically:

- 1) Press the **FPL** Key.
- 2) From the Active Flight Plan Page or from the Saved Flight Plan Page, press the **USE MAP** Softkey to activate the map pointer.
Or: Press the **MENU** Key and select 'Edit on Map'.
- 3) Move the **FMS** Joystick to highlight the desired waypoint to be removed from the flight plan.
- 4) Press the **CLR** Key. The 'Remove XXXX From Flight Plan?' window is displayed.
- 5) Press the **ENT** Key to accept. The waypoint is removed from the Active or Saved Flight Plan.

Graphical Flight Plan Editing:

- 1) Press the **FPL** Key.
- 2) From the Active Flight Plan Page or from the Saved Flight Plan Page, press the **USE MAP** Softkey to activate the map pointer.
Or: Press the **MENU** Key and select 'Edit on Map'.
- 3) Move the **FMS** Joystick to highlight the desired flight plan leg to be modified.

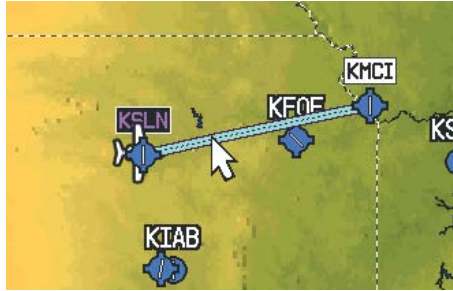

Flight Plan Page (Flight Plan Leg Highlighted with Map Pointer)

- 4) With the desired flight plan leg highlighted (blue), press the **ENT** Key (the flight plan leg turns magenta). This will grab the flight plan leg.
- 5) Using the **FMS** Joystick, drag the flight plan leg to highlight the desired waypoint to be inserted into the flight plan.

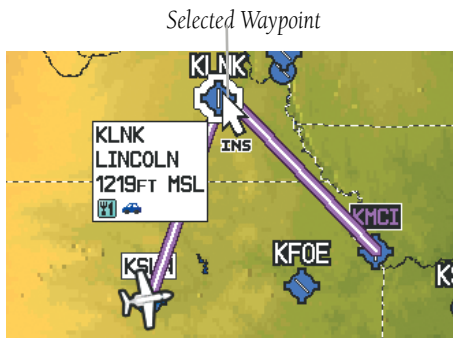

Flight Plan Page (Waypoint Selected with Map Pointer)

- 6) With the desired waypoint highlighted, press the **ENT** Key. The flight plan is now modified to include the added waypoint.

3.3 FLIGHT PLAN STORAGE

The GPSMAP 695/696 can store up to 50 flight plans. The active flight plan is erased when another flight plan is activated. Details about each stored flight plan can be viewed on the Flight Plan List Page.

Viewing information about a stored flight plan:

- 1) Press the **FPL** Key.
- 2) Turn the **FMS** Joystick to display the Flight Plan List Page.
- 3) Press the **FMS** Joystick to activate the cursor and turn or move the **FMS** Joystick to highlight the desired flight plan.
- 4) Press the **ENT** Key. The Saved Flight Plan Page is displayed showing Flight Plan name (departure and destination waypoints, by default), and the selected Data Fields.
- 5) Press the **FMS** Joystick or **DONE** Softkey to exit the Saved Flight Plan Page.

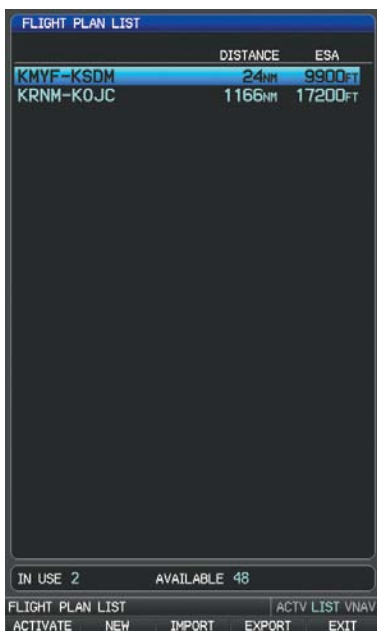

Flight Plan List Page

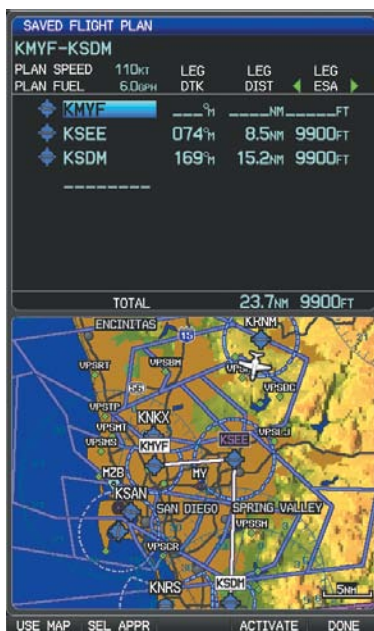

Saved Flight Plan Page

Storing an active flight plan from the Active Flight Plan Page:

- 1) Press the **FPL** Key.
- 2) Turn the **FMS** Joystick to select the Active Flight Plan Page.
- 3) Press the **MENU** Key. The Active Flight Plan Page Menu is displayed.
- 4) Turn or move the **FMS** Joystick to highlight 'Save Flight Plan'.
- 5) Press the **ENT** Key.
- 6) With 'Yes' highlighted, press the **ENT** Key. A copy of the flight plan is stored in the next available position in the flight plan list on the Flight Plan List Page.

3.4 FLIGHT PLAN ACTIVATION

Activating a stored flight plan erases the active flight plan and replaces it with a copy of the flight plan being activated. Inverting a stored flight plan reverses the waypoint order of the stored flight plan, (the active flight plan is not changed).

Activating a stored flight plan:

- 1) Press the **FPL** Key and turn the **FMS** Joystick to display the Flight Plan List Page.
- 2) Press the **FMS** Joystick to activate the cursor, and turn or move the **FMS** Joystick to highlight the desired flight plan.
- 3) Select the **ACTIVATE** Softkey; or press the **MENU** Key, highlight 'Activate Flight Plan', and press the **ENT** Key.
- 4) With 'Yes' highlighted, select the **ENT** Key. To cancel the request, press the **CLR** Key, the **FMS** Joystick, or highlight 'No' and press the **ENT** Key.

Activating a Flight Plan Leg:

- 1) Press the **FPL** Key.
- 2) Turn the **FMS** Joystick to display the Active Flight Plan Page.
- 3) Press the **FMS** Joystick to activate the cursor and move the **FMS** Joystick to highlight the waypoint leg to be activated.
- 4) Press the **Direct-to** Key twice. The "Activate Leg XXXXX - XXXXX?" window is displayed.



Activate Leg Window

- With 'Yes' highlighted, press the **ENT** Key. To cancel the request, press the **CLR** Key, the **FMS** Joystick, or highlight 'No' and press the **ENT** Key.

EDITING SPEED AND FUEL FLOW

Adjusting the Active Flight Plan fuel flow:

- Press the **MENU** Key twice to open the Main Menu.
- Turn or move the **FMS** Joystick to highlight 'Aircraft Profile', and press the **ENT** Key.



Aircraft Profile Page

- Select the desired aircraft or create a new one.
- Move the **FMS** Joystick to the 'Fuel Flow' field, turn the **FMS** Joystick to enter the appropriate fuel flow, and press the **ENT** Key.

Or:

- 1) Press the **FPL** Key and turn the **FMS** Joystick to display the Active Flight Plan Page.
- 2) Press the **FMS** Joystick to activate the cursor, and move the **FMS** Joystick to highlight the 'Fuel Flow' field.
- 3) Using the **FMS** Joystick, enter the desired fuel flow, and press the **ENT** Key.



Fuel Flow (Active Flight Plan Page)

Adjusting the Saved Flight Plan speed and fuel flow:

- 1) Press the **FPL** Key and turn the **FMS** Joystick to display the Flight Plan List Page.
- 2) Press the **FMS** Joystick to activate the cursor, and turn or move the **FMS** Joystick to highlight the desired flight plan, and press the **ENT** Key. The Saved Flight Plan Page is displayed.
- 3) Move the **FMS** Joystick to the 'Plan Speed' field.
- 4) Using the **FMS** Joystick, enter the desired speed, and press the **ENT** Key.
- 5) Repeat Steps 3 and 4 for 'Fuel Flow', and press the **DONE** Softkey.



Plan Speed and Fuel Flow (Saved Flight Plan Page)

COPYING FLIGHT PLANS

The GPSMAP 695/696 allows copying a flight plan into a new flight plan memory slot, allowing editing, etc., without affecting the original flight plan. This can be used to duplicate an existing stored flight plan for use in creating a modified version of the original stored flight plan.

Copying a stored flight plan:

- 1) Press the **FPL** Key and turn the **FMS** Joystick to display the Flight Plan List Page.
- 2) Press the **FMS** Joystick to activate the cursor, and turn or move the **FMS** Joystick to highlight the desired flight plan.
- 3) Press the **MENU** Key, using the **FMS** Joystick highlight 'Copy Flight Plan', and press the **ENT** Key.

DELETING FLIGHT PLANS

Individual or all stored flight plans can be deleted from the GPSMAP 695/696 memory.

Deleting a stored flight plan:

- 1) Press the **FPL** Key and turn the **FMS** Joystick to display the Flight Plan List Page.
- 2) Press the **FMS** Joystick to activate the cursor, and turn or move the **FMS** Joystick to highlight the desired flight plan.

- 3) Press the **CLR** Key; or press the **MENU** Key, highlight 'Delete Flight Plan', and press the **ENT** Key.
- 4) With 'Yes' highlighted, press the **ENT** Key to delete the flight plan. To cancel the request, press the **CLR** Key, the **FMS** Joystick, or highlight 'No' and press the **ENT** Key.

Deleting all stored flight plans:

- 1) Press the **FPL** Key and turn the **FMS** Joystick to display the Flight Plan List Page.
- 2) Press the **MENU** Key, highlight 'Delete All', and press the **ENT** Key.
- 3) With 'Yes' highlighted, press the **ENT** Key to delete all saved flight plans. To cancel the request, press the **CLR** Key, the **FMS** Joystick, or highlight 'No' and press the **ENT** Key.



NOTE: The changes made to the active flight plan affect navigation as soon as they are entered. Editing the active flight plan does not affect any saved flight plans. Waypoints in the final approach segment (such as the FAF or MAP) can not be deleted individually.

Deleting the Active Flight Plan:

- 1) Press the **FPL** Key to display the Active Flight Plan Page.
- 2) Press the **MENU** Key
- 3) With 'Stop Navigation' highlighted, press the **ENT** Key.

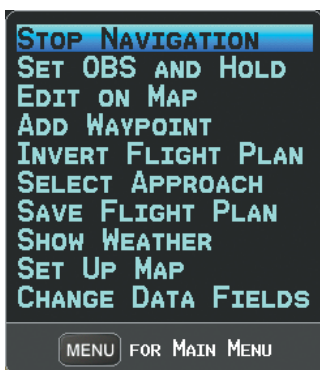

Active Flight Plan Page Menu

Deleting an individual waypoint from the active flight plan:

- 1) Press the **FPL** Key to display the Active Flight Plan Page.
- 2) Press the **FMS** Joystick to activate the cursor and turn or move the **FMS** Joystick to highlight the waypoint to be deleted.
- 3) Press the **CLR** Key. The 'Remove XXXXX From Flight Plan?' window is displayed.

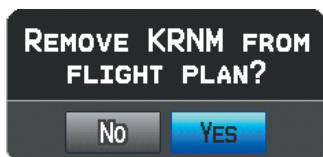

Remove Waypoint Window

- 4) With 'Yes' highlighted, press the **ENT** Key. To cancel the request, press the **CLR** Key, the **FMS** Joystick, or highlight 'No' and press the **ENT** Key.

Deleting an individual waypoint from a saved flight plan:

- 1) Press the **FPL** Key.
- 2) Turn the **FMS** Joystick to display the Flight Plan List Page if necessary.
- 3) Press the **FMS** Joystick to activate the cursor and turn or move the **FMS** Joystick to highlight the flight plan to be edited and press the **ENT** Key.
- 4) Move the **FMS** Joystick to highlight the waypoint to be deleted.
- 5) Press the **CLR** Key. The 'Remove XXXXX From Flight Plan?' window is displayed.
- 6) With 'Yes' highlighted, press the **ENT** Key. To cancel the request, press the **CLR** Key, the **FMS** Joystick, or highlight 'No' and press the **ENT** Key.

INVERTING A FLIGHT PLAN

Any flight plan may be inverted (reversed) for navigation back to the original departure point.

Inverting the active flight plan:

- 1) Press the **FPL** Key to display the Active Flight Plan Page.
- 2) Press the **MENU** Key, turn or move the **FMS** Joystick to highlight 'Invert Flight Plan', and press the **ENT** Key. An "Invert the Active Flight Plan?" confirmation window is displayed.

- 3) With 'Yes' highlighted, press the **ENT** Key to invert the active flight plan. To cancel, press the **CLR** Key, the **FMS** Joystick, or highlight 'No' and press the **ENT** Key.

Inverting a saved flight plan:

- 1) Press the **FPL** Key and turn the **FMS** Joystick to display the Flight Plan List Page.
- 2) Press the **FMS** Joystick to activate the cursor.
- 3) Move the **FMS** Joystick to highlight the desired flight plan, and press the **ENT** Key. The Saved Flight Plan Page is displayed.
- 4) Press the **MENU** Key, highlight 'Invert Flight Plan?', and press the **ENT** Key.
- 5) With 'Yes' highlighted, press the **ENT** Key. To cancel the request, press the **CLR** Key, the **FMS** Joystick, or highlight 'No' and press the **ENT** Key.

IMPORTING/EXPORTING FLIGHT PLANS

Importing flight plans:

- 1) With a flight plan saved to the SD Card, press the **FPL** Key and turn the **FMS** Joystick to display the Flight Plan List Page.
- 2) Press the **IMPORT** Softkey.
- 3) Using the **FMS** Joystick highlight the desired flight plan to import.
- 4) Press the **IMPORT** Softkey and press the **ENT** Key.

Or: Press **Menu** and with "Import Flight Plan" highlighted press **ENT**.

Exporting flight plans:

- 1) Press the **FPL** Key and turn the **FMS** Joystick to display the Flight Plan List Page.
- 2) Press the **FMS** Joystick to activate the cursor, and turn or move the **FMS** Joystick to highlight the desired flight plan.
- 3) Press the **EXPORT** Softkey and press the **ENT** Key.

Or: Press **Menu** and with "Export Flight Plan" highlighted press **ENT**.

3.5 APPROACHES



WARNING: The GPSMAP 695/696 is not designed to be independently used for flight into instrument meteorological conditions (IMC) or other conditions in which aircraft control is based solely upon flight instruments. The approaches provided are for monitoring purposes only. Only the final course segment (final approach fix (FAF) to missed approach point (MAP)) of the published approach is available for monitoring.

An approach can be loaded at any airport that has one available, and provides guidance for non-precision and precision approaches to airports with published instrument approach procedures. Only one approach can be loaded at a time in a flight plan. If an approach is loaded when another approach is already in the active flight plan, the new approach replaces the previous approach. Only the final course segment (Final Approach Fix (FAF) to Missed Approach Point (MAP)) of the published approach is available for monitoring.

Whenever an approach is selected, the choice to either “Load Approach” or “Activate Approach” is given. “Load Approach” adds the approach to the end of the flight plan without immediately using it for navigation guidance. This allows continued navigation via the intermediate waypoints in the original flight plan, but keeps the procedure available on the Active Flight Plan Page for quick activation when needed. “Activate Approach” also adds the procedure to the end of the flight plan but immediately begins to provide guidance to the first waypoint in the approach.

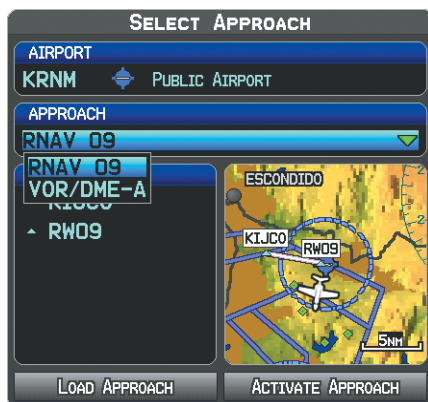

Select Approach Window

SELECTING AN APPROACH

When an approach is selected and activated, it replaces the destination airport with the sequence of waypoints for the selected approach. When an approach is loaded, the destination airport remains in the flight plan and the approach sequence of waypoints are appended to the flight plan. Keep in mind that the airport must have a published approach (GPS, RNAV, VOR, NDB, localizer, or ILS) and only the final course segment (final approach fix to missed approach point) of the published approach is available in the GPSMAP 695/696.

An approach can be selected from the Direct-to Window, Waypoint (WPT) Page, Active Flight Plan Page, and the Saved Flight Plan Page.

Loading an approach from the active or saved flight plan page:

- 1) Press the **FPL** Key.
- 2) Turn the **FMS** Joystick to display the Active Flight Plan Page or Saved Flight Plan Page.
- 3) Press the **SEL APPR** Softkey; or press the **MENU** Key, highlight 'Select Approach' by turning or moving the **FMS** Joystick, and press the **ENT** Key. The Select Approach Window is displayed.
- 4) Turn the **FMS** Joystick to access a list of available approaches. Turn or move the **FMS** Joystick to highlight the desired approach and press the **ENT** Key.
- 5) With 'Load Approach' highlighted, press the **ENT** Key. To cancel the request, press the **CLR** Key or the **FMS** Joystick.

Viewing a chart for the selected approach:

- 1) With an approach selected in the Select Approach Window, press the **MENU** Key. The Show Chart Menu is displayed.



Select Approach Menu

- 2) Press the **ENT** Key. A chart displaying the selected approach is displayed.
- 3) Press the **EXIT** Softkey to return to the Select Approach Window.

Activating an approach on the Active Flight Plan Page:

- 1) Press the **FPL** Key.
- 2) Turn the **FMS** Joystick to display the Active Flight Plan Page (if necessary).
- 3) Press the **SEL APPR** Softkey; or press the **MENU** Key, highlight 'Select Approach' by turning or moving the **FMS** Joystick, and press the **ENT** Key. The Select Approach Window is displayed.
- 4) Turn the **FMS** Joystick to access a list of available approaches. Turn or move the **FMS** Joystick to highlight the desired approach and press the **ENT** Key.
- 5) With 'Activate Approach' highlighted, press the **ENT** Key. To cancel the request, press the **CLR** Key or the **FMS** Joystick.

Or:

- a) With an approach loaded on the Active Flight Plan Page, press the **MENU** Key.
- b) Turn or move the **FMS** Joystick to highlight 'Activate Approach', and press the **ENT** Key.

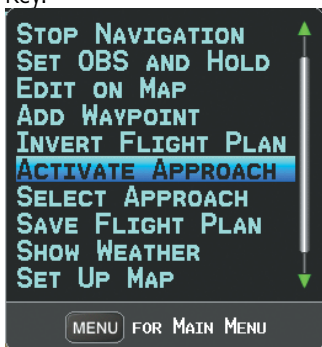

Active Flight Plan Page Menu

Or:

- a) With an approach loaded on the Active Flight Plan Page, press the **FMS** Joystick to activate the cursor.
- b) Move the **FMS** Joystick to highlight the approach, and press the **ENT** Key. "Activate XXXXX Approach?" window is displayed.
- c) With 'Yes' highlighted, press the **ENT** Key.

Loading/Activating an approach from the Direct-to Window or Waypoint Page:

- 1) Press the **Direct-to** Key or select the Waypoint Page.
- 2) Press the **MENU** Key.
- 3) Turn or move the **FMS** Joystick to highlight 'Select Approach', and press the **ENT** Key. If an approach is not already loaded or activated, the cursor is displayed in the Approach Field. If an approach is already loaded or activated, 'Activate' is highlighted.
- 4) With 'Activate' highlighted press the **ENT** Key, or select an approach, highlight 'Load Approach' or 'Activate Approach', and press the **ENT** Key.

Removing an approach:

- 1) Press the **FPL** Key.
- 2) Turn the **FMS** Joystick to display the Active Flight Plan Page or Saved Flight Plan Page.
- 3) Press the **RMV APPR** Softkey, and press the **ENT** Key.

Or: On the Saved Flight Plan Page, press the **MENU** Key and highlight 'Remove Approach' and press the **ENT** Key.

ACTIVATING VECTORS-TO-FINAL

After an approach has been activated, the **VECTORS** Softkey is used when being vectored to the final approach course by Air Traffic Control (ATC).

If the **VECTORS** Softkey is selected, the GPSMAP 695/696 creates an extension of the final course, beyond the final approach waypoint in the database (final approach fix [FAF]). On the Active Flight Plan Page, a Vectors-to-Final symbol appears beside the first approach waypoint.

Vectors-to-Final Symbol

The screenshot displays the 'ACTIVE FLIGHT PLAN' screen. At the top, it shows 'ENROUTE' with a diamond symbol and 'KCRQ'. Below this, it lists 'APPROACH - KOKB GPS 24 (VECTORS TO FINAL)'. Two approach waypoints are shown: 'OCNIH' and 'RW24', both with a triangle symbol. The 'OCNIH' entry includes '247°M', '5.2NM', and '03:10'. The 'RW24' entry includes '247°M', '5.0NM', and '03:02'. A 'TOTAL' bar at the bottom of the data section shows '5.2NM 03:08'. Below the data is a map showing the flight path with a blue dashed line. A purple line extends from the 'OCNIH' waypoint, labeled as the 'Final Course Extension'. A white airplane icon is positioned at the 'KCRQ' airport. The bottom of the screen features a menu with 'VECTORS' highlighted, and other options like 'USE MAP', 'SEL APPR', 'RMV APPR', and 'EXIT'. A '2NM overZoom' scale bar is also visible on the map.

Final Course Extension

VECTORS Softkey

Vectors-to-Final (Active Flight Plan Page)

The GPSMAP 695/696 provides no guidance to the inbound course. The course deviation needle on the graphic HSI remains off-center until established on the final approach course. The map shows an extension of the final approach course using a bold magenta line.

If the **VECTORS** Softkey is not selected, the GPSMAP 695/696 creates a straight-line course directly to the first waypoint in the approach.

Cancelling Vectors-to-Final:

From the Active Flight Plan Page (with an approach activated), press the **VECTORS** Softkey.

Or:

- 1) From the Active Flight Plan Page, press the **MENU** Key.
- 2) Turn or move the **FMS** Joystick to highlight 'Cancel Vectors-to-Final' and press the **ENT** Key.

3.6 TRIP PLANNING

Refer to Appendix F (Utilities) for information on Flight Log, Track Log, E6B Calculator, Aircraft Profile, and Weight & Balance.

Blank Page

SECTION 4 HAZARD AVOIDANCE

4.1 WEATHER INFORMATION

WEATHER SOURCE

With a SiriusXM subscription and FIS-B weather information (through GDL 39), there are three options available for selection through the Main Menu or Weather Page; AUTO, XM (SiriusXM), and GDL FIS-B. The default selection is 'AUTO.' With AUTO selected, and a SiriusXM subscription, SiriusXM weather information is displayed. If SiriusXM service is unavailable with AUTO selected, FIS-B weather information is displayed, if available. If either SiriusXM or FIS-B source is selected, only the selected source is used to display weather information and no automatic source-switching will occur. When more than one source is available, the name of the current weather source will be displayed in the title bar of the Weather Page (WX) and on the Waypoint Page when the Weather Softkey is selected. Data from the selected weather source will apply to all weather shown on the Map Page, Waypoint Page, Weather Page, Nearest Page, and configurable data fields. The weather source can also be changed manually through the Main Menu or on the Weather Page (WX).

Switching Weather Sources:

- 1) Press the **MENU** Key twice to display the Main Menu.
- 2) Turn or move the **FMS** Joystick to highlight 'System Setup...' and press the **ENT** Key.
- 3) Turn or move the **FMS** Joystick to highlight 'WEATHER.'
- 4) Press the **ENT** Key.
- 5) Turn or move the **FMS** Joystick to select the desired weather source (AUTO, XM, or GDL FIS-B). The default is 'AUTO' which will use XM over GDL FIS-B if both are available.
- 6) Press the **FMS** Joystick, the **CLR** Key, or the **EXIT** Softkey to return to the previous page.

Or

- 1) From the Weather Page press **SETUP** Softkey.
- 2) Turn or move the **FMS** Joystick to select the desired weather source (AUTO, XM, or GDL FIS-B). The default is 'AUTO' which will use XM over GDL FIS-B weather if both are available.
- 3) Press the **FMS** Joystick, the **CLR** Key, or the **EXIT** Softkey to return to the previous page.

SIRIUSXM WEATHER (696 ONLY)



NOTE: SiriusXM Weather is only available with the GPSMAP 696.

ACTIVATING SERVICES

Before SiriusXM Weather can be used, the service must be activated. Service is activated by providing SiriusXM Satellite Radio with a Radio ID unique to the GXM 40 antenna.

SiriusXM Satellite Radio uses the Radio ID to send an activation signal that allows the GPSMAP 696 to display weather data and/or entertainment programming provided through the GXM 40 antenna.

Refer to the GXM 40 Owner's Manual for more information on activating SiriusXM Satellite Radio.

SIRIUSXM WEATHER INFORMATION

- Radio ID—Eight-digit ID number used for activation.
- Service Level—SiriusXM Weather subscription plan purchased.
- Weather Products—List of weather features and age of weather data in minutes.

Accessing SiriusXM Weather information:

From the SiriusXM Audio Page press the **INFO** Softkey.

Or:

- 1) From the WX Page press the **MENU** Key to display the WX Page Menu.
- 2) Turn or move the **FMS** Joystick to highlight 'WEATHER PRODUCTS' and press the **ENT** Key.

SIRIUSXM WEATHER PRODUCTS

NEXRAD

NEXRAD (NEXT-generation RADar), is a network of multiple high-resolution Doppler radar sites that are operated by the National Weather Service (NWS). NEXRAD data provides centralized meteorological information for the continental United States and selected overseas locations. The maximum range of a single NEXRAD radar site is 250 nm. In addition to a wide array of services, the NEXRAD network provides important information about severe weather and air traffic safety.

NEXRAD data is not real-time. The lapsed time between collection, processing, and dissemination of NEXRAD images can be significant and may not reflect the current radar synopsis. Due to the inherent delays and the relative age of the data, it should be used for long-range planning purposes only. Never use NEXRAD data or any radar data to maneuver in or near areas of hazardous weather. Rather, use it in an early-warning capacity of pre-departure and enroute evaluation.

Composite data from all the NEXRAD radar sites in the United States is shown. This data is composed of the maximum reflectivity from the individual radar sweeps. The display of the information is color-coded to indicate the weather severity level.

The display of radar coverage is always active when NEXRAD is selected. Areas where NEXRAD radar coverage is not currently available or is not being collected are indicated in grayish-purple (Weather (WX) Page Only). Radar capability may exist in these areas, but it is not active or is off-line.

NEXRAD ABNORMALITIES

There are possible abnormalities regarding displayed NEXRAD images. Some, but not all, of those include:

- Ground clutter
- Strokes and spurious radar data
- Sun strokes, when the radar antenna points directly at the sun
- Military aircraft deploy metallic dust (chaff) which can cause alterations in radar scans
- Interference from buildings or mountains, which may cause shadows

NEXRAD LIMITATIONS

Certain limitations exist regarding the NEXRAD radar displays. Some, but not all, are listed for the user's awareness:

- NEXRAD base reflectivity does not provide sufficient information to determine cloud layers or precipitation characteristics (hail vs. rain). For example, it is not possible to distinguish between wet snow, wet hail, and rain.
- NEXRAD base reflectivity is sampled at the minimum antenna elevation angle. An individual NEXRAD site cannot depict high altitude storms at close ranges, and has no information about storms directly over the site.
- Radar coverage only extends to 55°N.
- Any precipitation displayed between 52°N and 55°N is unknown.

NEXRAD INTENSITY

Colors are used to identify the different NEXRAD echo intensities (reflectivity) measured in dBZ (decibels of Z). "Reflectivity" (designated by the letter Z) is the amount of transmitted power returned to the radar receiver. The dBZ values increase as returned signal strength increases. Precipitation intensity is displayed using colors corresponding to the dBZ values.

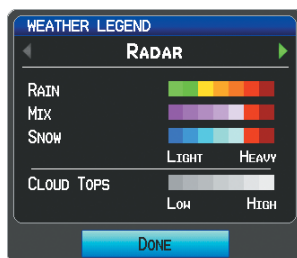

RADAR Legend

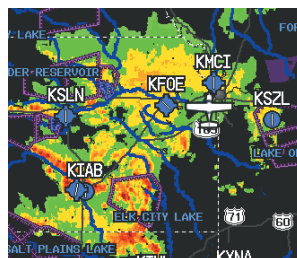

NEXRAD Data

SATELLITE MOSAIC

Satellite Mosaic displays infrared composite images of cloud cover taken by geostationary weather satellites. The Satellite Mosaic provides up to seven levels of cloud cover.

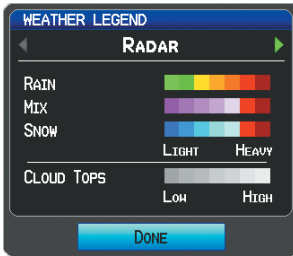

RADAR Legend

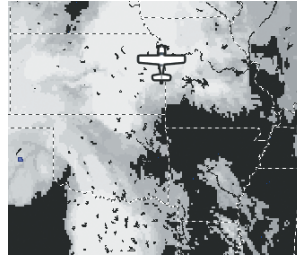

Satellite Mosaic/Cloud Tops Data

ECHO TOPS

Echo Tops are derived from NEXRAD radar and indicate the highest altitude at which precipitation is falling. Echo Tops at or above the altitude you select are displayed, in 5,000 foot increments up to 70,000 ft. Echo Tops can be helpful in determining the severity of thunderstorms.

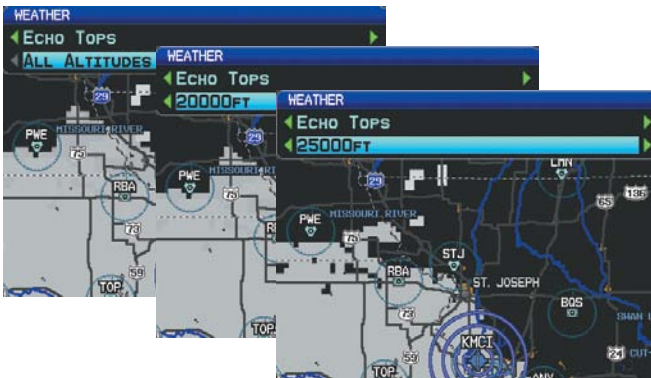

Echo Tops Data

WINDS ALOFT

Winds Aloft data shows the forecasted wind speed and direction at the surface and at selected altitudes. Altitudes can be displayed in 3,000-foot increments up to 42,000 feet MSL.

Winds Aloft are displayed using wind barbs or a wind streamline depending on the selected range. The wind barbs indicate wind speed and direction. The wind streamline indicates wind direction with arrows.

The wind barbs always point in the direction that the wind is coming from. The wind speed is depicted using flags at the end of the wind barb. A short wind flag is 5 mph, a long wind flag is 10 mph, and a triangle flag is 50 mph.



Winds Aloft Data

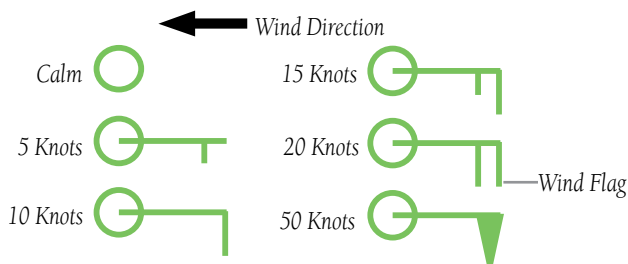

Winds Barbs

SURFACE PRESSURE

This feature displays pressure isobars and pressure centers. The isobars connect points of equal pressure. Pressure readings can help determine weather and wind conditions. High pressure areas are generally associated with fair weather. Low pressure areas are generally associated with clouds and the chance of precipitation. Isobars that are packed closely together show a strong pressure gradient. Strong gradients are associated with areas of stronger winds. Pressure units can be displayed in Millibars (mb), Inches of Mercury (in), and Hectopascals (hPa).

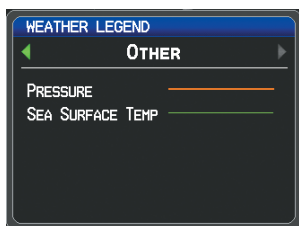

Other Legend

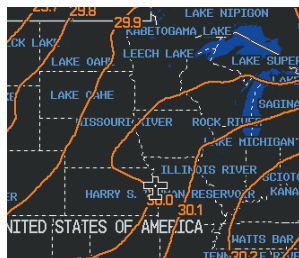

Surface Pressure Data

SIRIUSXM LIGHTNING

Lightning data shows the approximate location of cloud-to-ground lightning strikes. A strike icon represents a strike that has occurred within a two-kilometer region and within the last seven minutes. The exact location of the lightning strike is not displayed.

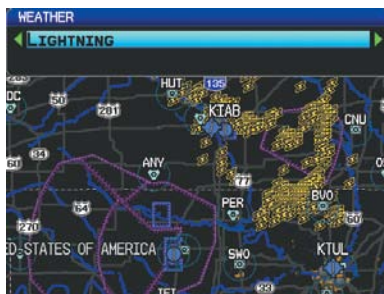

Lightning Data

STORM CELLS

The Storm Cells feature displays storms as well as the storm's projected path in the immediate future.

The direction of the storm is displays by an arrow (at a range of 20 nm or less). The tip of the arrow indicates where the storm should be in 15 minutes. Critical information about the storm cell (tops and intensity) can be viewed by selecting the storm cell with the Map Pointer. Pressing the **ENT** Key will display additional information.

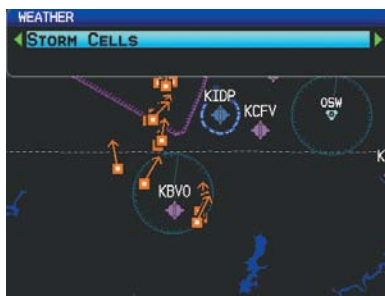

Storm Cell Data

METARs AND TAFs



NOTE: METAR information is only displayed within the installed navigation database service area.

METAR (METeorological Aerodrome Report) is the standard format for weather briefings. METARs are updated hourly and are considered current. METARs typically contain information about the temperature, dewpoint, wind, precipitation, cloud cover, cloud heights, visibility, and barometric pressure. They can also contain information on precipitation amounts, lightning, and other critical data. METARs are shown as colored flags at airports that provide them.

TAF (Terminal Area Forecast) is the standard format for 24-hour weather forecasts. TAFs may contain some METAR data, but generally cover a smaller area. It typically forecasts significant weather changes, temporary changes, probable changes, and expected changes in weather conditions.

METAR and TAF text are displayed on the Map Page and the Weather (WX) Page. An abbreviated version can be viewed by panning over the METAR flag. Pressing the **ENT** Key will display additional information. METAR and TAF data can be displayed as raw or decoded text.

Changing METAR and TAF text:

- 1) Using the Map Pointer, select the desired METAR and press the **ENT** Key; or from the Waypoint (WPT) Page press the **WEATHER** Softkey. The Weather Information Page is displayed.
- 2) Press the **MENU** Key.
 - a) Select 'Show Decoded Text' or 'Show Raw Text'.
 - b) Press the **ENT** Key.

Or:

 - a) Select 'Change Text Size' and press the **ENT** Key.
 - b) Select 'Small', 'Medium', or 'Large' and press the **ENT** Key.

The METAR flag color is determined by the information in the METAR text. The METAR flag is gray when the METAR text does not contain adequate information to determine flight conditions.

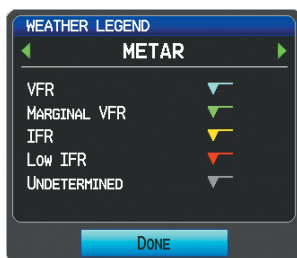

METAR Legend

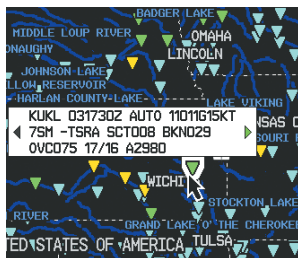

METAR Selected With Map Pointer

AIRMETS

An AIRMET (AIRMen's METeorological Information) can be especially helpful for pilots of light aircraft that have limited flight capability or instrumentation. An AIRMET must affect or be forecast to affect an area of at least 3,000 square miles at any one time. AIRMETS are routinely issued for six-hour periods and are amended as necessary due to changing weather conditions. AIRMETS are displayed as colored, dashed lines.

SIGMETS

A SIGMET (SIGnificant METeorological Information) advises of weather that is potentially hazardous to all aircraft. In the contiguous United States, the following items are covered: severe icing, severe or extreme turbulence, volcanic ash, dust storms, and sandstorms that lower visibility to less than three statute miles.

A Convective SIGMET is issued for the following conditions: thunderstorms, isolated severe thunderstorms, embedded thunderstorms, hail at the surface, and tornadoes.

A SIGMET is widespread and must affect or be forecast to affect an area of at least 3,000 square miles. SIGMETs are displayed as a yellow-dashed line.

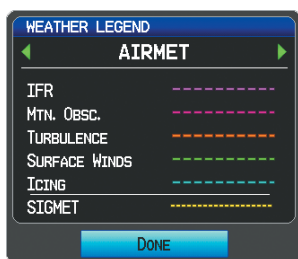

AIRMET/SIGMET Legend

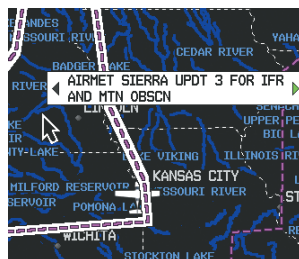

AIRMET Selected With Map Pointer

TEMPORARY FLIGHT RESTRICTIONS (TFR)



NOTE: Do not rely solely upon data link services to provide Temporary Flight Restriction TFR information. Always confirm TFR information through official sources such as Flight Service Stations of Air Traffic Control.

Temporary Flight Restrictions, or TFRs, temporarily restrict all aircraft from entering the selected airspace unless a waiver has been issued. TFRs are routinely issued for activities such as sporting events, dignitary visits, military depots, and forest fires. TFRs are represented as an area highlighted by red (active) or yellow (not yet active).

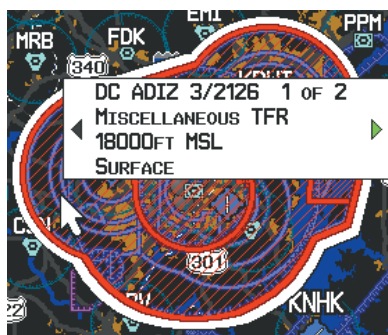

TFR Data

PIREPs

Pilot Weather Reports (PIREPs) provide timely weather information. When significant weather conditions are reported or forecast, Air Traffic Control (ATC) facilities are required to solicit PIREPs. A PIREP may contain unforecast adverse weather conditions, such as low in-flight visibility, icing conditions, wind shear, and turbulence. PIREPs are issued as either Routine (UA) (blue) or Urgent (UUA) (yellow).

PIREP text is displayed on the Weather (WX) Page. An abbreviated version can be viewed by panning over the PIREP box. Using the Map Pointer, highlight the desired PIREP and press the **ENT** Key to display the decoded text.



PIREP Data on Weather Page



Decoded PIREP Data

FREEZING LEVELS

Freezing Level shows contours for the lowest forecast altitude where icing conditions are likely to occur.

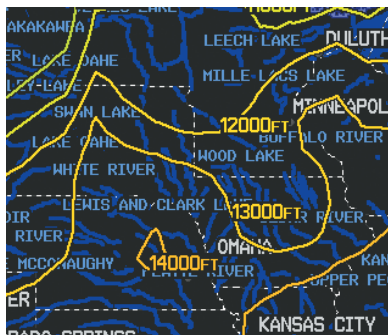

Freezing Level Data

TURBULENCE FORECAST

Turbulence data identifies the potential for erratic movement of high-altitude air mass associated winds. Turbulence is classified as light, moderate, severe, or extreme. Turbulence data is intended to supplement AIRMETs and SIGMETs.

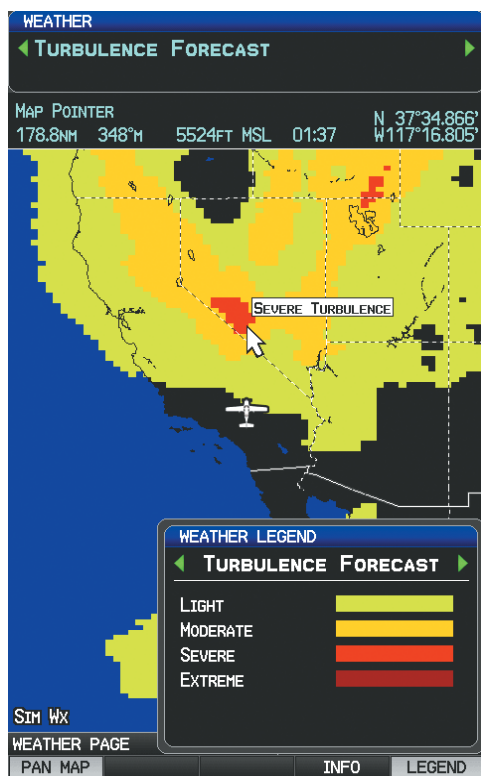

Turbulence Data and Legend

ICING FORECAST (CIP & SLD)

Current Icing Product (CIP) data shows a graphical view of the current icing environment. Icing severity is displayed in four categories: light, moderate, severe, and extreme (not specific to aircraft type). The CIP product is not a forecast, but a representation of the current conditions at the time of the analysis. Altitudes can be displayed in 3,000-foot increments up to 30,000 feet MSL.

Supercooled Large Droplet (SLD) icing conditions are characterized by the presence of relatively large, supercooled water droplets indicative of freezing drizzle and freezing rain aloft. SLD threat areas are depicted as magenta dots over the CIP colors.

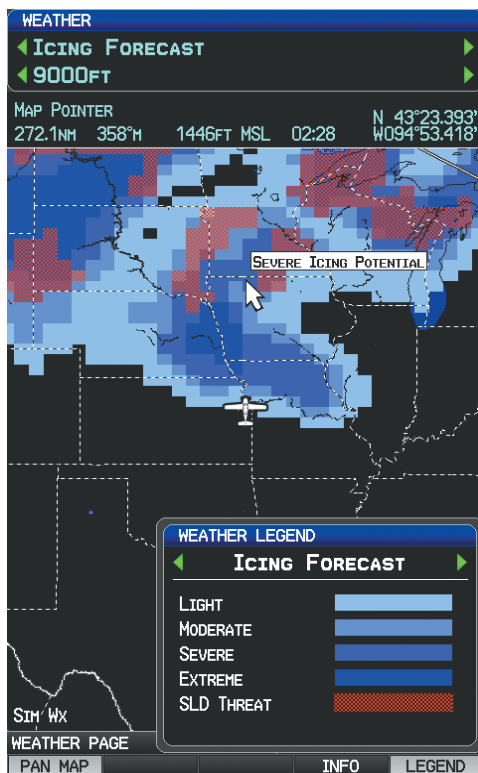

Icing Forecast Data and Legend

Overview

GPS Navigation

Flight Planning

Hazard Avoidance

Additional Features

Appendices

Index

FORECAST

Forecast information is available for current and forecast weather conditions. Forecasts are available for intervals of 12, 24, 36, and 48 hours.

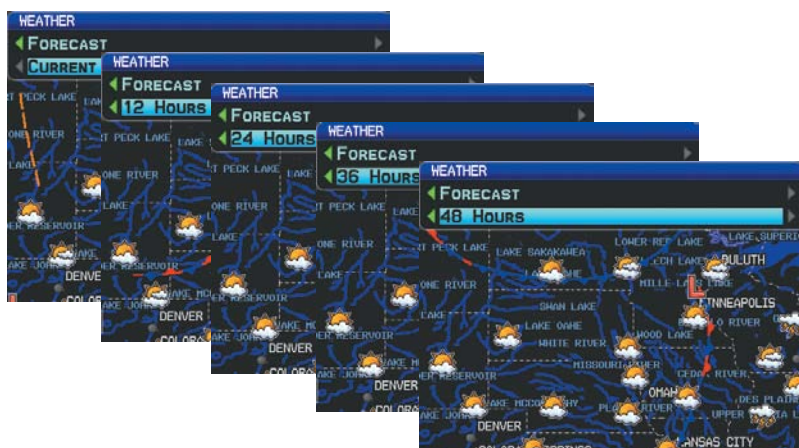

Forecast Data

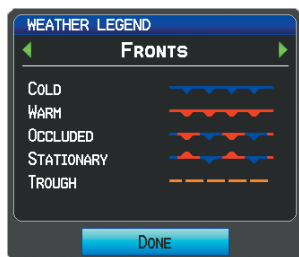

Fronts Legend



Forecast Legend

SEA SURFACE TEMPERATURE

Overview

GPS Navigation

Flight Planning

Hazard Avoidance

Additional Features

Appendices

Index



NOTE: Sea Surface Temperature data requires Master Mariner SiriusXM subscription.

The surface temperatures of coastal and large inland bodies of water are displayed.

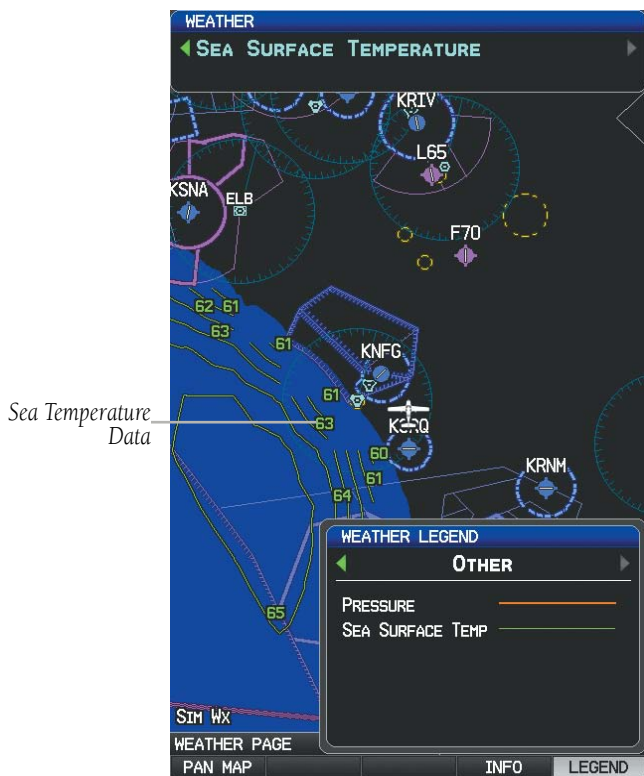

Sea Temperature Data and Legend

USING SIRIUSXM WEATHER PRODUCTS



WARNING: Do not use data link weather information for maneuvering in, near, or around areas of hazardous weather. Information contained within data link weather products may not accurately depict current weather conditions.



WARNING: Do not use the indicated data link weather product age to determine the age of the weather information shown by the data link weather product. Due to time delays inherent in gathering and processing weather data for data link transmission, the weather information shown by the data link weather product may be significantly older than the indicated weather product age.

SiriusXM Weather Products can be displayed on the Map Page and individually on the Weather (WX) Page.

The setup menu for the Navigation Map controls the map range settings above which weather products are decluttered from the display. If a map range larger than the weather product map range setting is selected, the weather product data is removed from the map. For weather products such as METAR, Lightning, and Storm Cells, the weather product is displayed when a map range "smaller" than the weather product map range setting is selected (Satellite Mosaic works inversely). The menu also provides a means for enabling/disabling display of 'Airmets', 'Sigmets', 'Weather Data', 'NEXRAD', and/or 'Fronts' on the Navigation Map.

Additional information about the following can be displayed by panning over the display on the map:

- Storm Cells
- SIGMETs
- AIRMETs
- METARs
- TFRs

Additional information is also available for the following weather products on the Weather Map (not displayed on the Navigation Map):

- Forecast
- PIREPs

Viewing SiriusXM Weather products on the Map Page:

- 1) Select the Map Page.
- 2) Select the **WEATHER** Softkey to display the SiriusXM Weather products.

Or:

- a) Press the **MENU** Key.
 - b) Select 'Show Weather' and press the **ENT** Key.
- 3) Press the **FMS** Joystick to activate the Map Pointer.
 - 4) Use the **FMS** Joystick to highlight the desired weather product with the Map Pointer.
 - 5) With the desired weather product highlighted, press the **ENT** Key to get detailed information (if available).

Viewing SiriusXM Weather products on the Weather (WX) Page:

- 1) From the WX Page press the **FMS** Joystick to highlight the weather product field.
- 2) Turn the **FMS** Joystick to select and automatically display the desired weather product.
- 3) If necessary, move the **FMS** Joystick to highlight the type field and turn the **FMS** Joystick to scroll through a list of available options.
- 4) Press the **PAN MAP** Softkey to get abbreviated information about the selected weather product or map feature (if available).
- 5) With the desired weather product selected press the **ENT** Key to get detailed information (if available).



Abbreviated Weather Product Information



Detailed Weather Product Information

Setting up and customizing weather data for the Map Page:

- 1) From the Map Page press the **MENU** Key.
- 2) Turn or move the **FMS** Joystick to highlight 'Set Up Map' and press the **ENT** Key.
- 3) Turn the **FMS** Joystick to select the 'XM Weather' or 'XM WX Reports' Category from the horizontal list.
- 4) Move the **FMS** Joystick to select the desired weather product.
- 5) Turn the **FMS** Joystick to access a list of options for each product (On/Off, Auto, range settings).
- 6) Press the **ENT** Key to select an option.
- 7) Press the **FMS** Joystick, the **CLR** Key, or the **EXIT** Softkey to return to the Map Page with the changed settings.

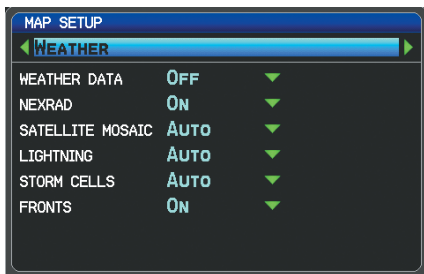

Map Setup Page (Weather Category)



Map Setup Page (WX Report Category)

Restoring default weather data for the Map Page:

- 1) From the Map Page press the **MENU** Key.
- 2) Turn or move the **FMS** Joystick to highlight 'Set Up Map' and press the **ENT** Key.
- 3) Turn the **FMS** Joystick to select 'XM Weather' or 'XM WX Reports'.
- 4) Move the **FMS** Joystick to select the desired weather product.
- 5) Press the **MENU** Key.
- 6) With 'Restore Default' or 'Restore All Map Defaults' selected, press the **ENT** Key.
- 7) Press the **FMS** Joystick, the **CLR** Key, or the **EXIT** Softkey to return to the Map Page with the restored settings.

Viewing legends for displayed weather products:

- 1) From the Map Page press the **MENU** Key to access the Map Page Menu.
- 2) Turn or move the **FMS** Joystick to select 'Weather Legend' and press the **ENT** Key to display the Weather Legend Window.
- 3) Turn the **FMS** Joystick to view the desired weather legend (Radar, Fronts, METAR, AIRMET, Turbulence Forecast, or Other).
- 4) With '**DONE**' highlighted, press the **ENT** Key to return to the Map Page.

Or:

- 1) From the Weather (WX) Page press the **LEGEND** Softkey to display the Weather Legend Window.
- 2) Turn the **FMS** Joystick to view the desired weather legend (Radar, Fronts, METAR, AIRMET, Turbulence Forecast, or Other).
- 3) With '**DONE**' highlighted, press the **ENT** Key to return to the Weather (WX) Page.

Animating SiriusXM Weather:

- 1) From the Map Page press the **MENU** Key to access the Map Page Menu.
- 2) Turn or move the **FMS** Joystick to select 'Animate Weather' and press the **ENT** Key.
- 3) To stop animation, press the **MENU** Key again, turn or move the **FMS** Joystick to select 'Stop Animation' and press the **ENT** Key.

Or:

- 1) Select the Weather (WX) Page.
 - 2) Using the **FMS** Joystick select either the 'NEXRAD Radar' or 'Satellite Mosaic' weather product.
 - 3) Select the **ANIMATE** Softkey to begin animation
- Or:**
- a) Press the **MENU** Key.
 - b) Select 'Animate Weather' and press the **ENT** Key to begin animation.
- 4) To stop animation, press the **MENU** Key again, turn or move the **FMS** Joystick to select 'Stop Animation' and press the **ENT** Key.

DATA LINK WEATHER (FIS-B)

The GPSMAP 695/696 is compatible with the GDL 39 data link radio. The GDL 39 is a receive-only data link radio with on-board GPS, 978 MHz (the Universal Access Transceiver frequency band), and 1090 MHz Extended Squitter (1090 ES) receivers. It is designed to receive, process, and output traffic (ADS-B air-to-air, and TIS-B traffic information), and weather (Flight Information Service-Broadcast (FIS-B)) information to the GPSMAP 695/696 through a power/data cable. As a UAT receiver, the GDL 39 can receive and, when connected to the GPSMAP 695/696, display Flight Information Service-Broadcast (FIS-B) weather products as well as traffic.

FIS-B is a free weather service that is broadcast by Ground Based Transceivers (GBTs) over the 978 MHz UAT frequency band as part of the FAA's Next Generation Air Transportation System (NextGen). To receive FIS-B weather information, the GDL 39 must be within range and line-of-sight of an operating GBT. Reception may be affected by altitude, terrain, and other factors. GDL 39-supported FIS-B weather products include METARs, TAFs, NEXRAD (Regional and CONUS (Combined)), AIRMETS, SIGMETs, PIREPs, and Winds and Temperatures Aloft. Other products include NOTAMs and TFRs.

Switching Weather Sources:

- 1) Press the **MENU** Key twice to display the Main Menu.
- 2) Turn or move the **FMS** Joystick to highlight 'System Setup...' and press the **ENT** Key.
- 3) Turn or move the **FMS** Joystick to highlight 'WEATHER'.
- 4) Press the **ENT** Key.
- 5) Turn or move the **FMS** Joystick to select the desired weather source (AUTO, XM, or GDL FIS-B). The default is 'AUTO' which will use XM over GDL FIS-B if both are available.
- 6) Press the **FMS** Joystick, the **CLR** Key, or the **EXIT** Softkey to return to the previous page.

Or

- 1) From the Weather Page press **SETUP** Softkey.
- 2) Turn or move the **FMS** Joystick to select the desired weather source (AUTO, XM, or GDL FIS-B). The default is 'AUTO' which will use XM over GDL FIS-B if both are available.
- 3) Press the **FMS** Joystick, the **CLR** Key, or the **EXIT** Softkey to return to the previous page

Viewing FIS-B Product Status:

- 1) Press the **MENU** Key twice to display the Main Menu.
- 2) Turn or move the **FMS** Joystick to highlight 'Data Link Information' and press the **ENT** Key.
- 3) Press the **WEATHER** Softkey, to view the age in hours:minutes of each weather product.

Or:

- 1) From the Weather Page, press the **INFO** Softkey.

Viewing Ground Station Status:

- 1) Press the **MENU** Key twice to display the Main Menu.
- 2) Turn or move the **FMS** Joystick to highlight 'Data Link Information' and press the **ENT** Key.
- 3) Press the **STATIONS** Softkey, to view ground station(s) status (Active/Inactive), bearing, and distance.

Or:

- 1) From the Weather Page, press the **INFO** Softkey.
- 2) Press the **STATIONS** Softkey, to view ground station(s) status bearing and distance.

FIS-B WEATHER PRODUCTS

FIS-B weather broadcasts are updated regularly and may take approximately ten minutes to transmit all available weather data. Therefore, weather data is not immediately available. No pilot action is required to receive FIS-B weather information. Weather product status can be viewed on the dedicated Weather Page, or the Data Link Page from the Tools menu.

When a FIS-B weather product is active on a map, the age of the data is displayed on the screen in the lower left corner. The age of the product is based on the time difference between when the data was assembled on the ground and the current GPS time. Weather products are broadcast at specific intervals (see broadcast interval in the table below).

If, for any reason, a weather product is not refreshed within the Expiration Time intervals (see table), the data is considered expired and is removed from the display. This ensures that only data that is consistent with FIS-B broadcast data is displayed. If more than half of the expiration time has elapsed, the color of the product age displayed changes to yellow. The system displays dashes instead of a product age when a product has expired. If a weather product is not available or has not been received, the system displays 'N/A' instead of a product age.

The table below shows the FIS-B weather expiration time and the broadcast interval. The broadcast interval represents the interval at which FIS-B GBTs broadcast new signals that may or may not contain new weather data. It does not represent the rate at which weather data is updated or new content is received by the GDL 39.

FIS-B Products	Expiration Time	Update Interval (Minutes)	Broadcast Interval (Minutes)
NEXRAD Composite Reflectivity (CONUS)	60 minutes	~5 minutes precipitation mode 10 minutes for clear air	15
NEXRAD Composite Reflectivity (Regional)	60 minutes	As Available	2.5
METAR	8 hours	1 minute (where available), As Available otherwise	5
TAF	12 hours	8 hours	10
AIRMET	12 hours	As Available	5
SIGMET	12 hours	As Available, then at 15 minute intervals for 1 hour	5
PIREP	8 hours	As Available	10

FIS-B Products	Expiration Time	Update Interval (Minutes)	Broadcast Interval (Minutes)
Winds and Temperatures Aloft	12 hours	12 hours	10
NOTAM (D)/FDC (Including TFRs)	12 hours	As Available	10

Weather Product Timing

NEXRAD

NEXRAD (NEXT-generation RADar), is a network of multiple high-resolution Doppler radar sites that are operated by the National Weather Service (NWS). NEXRAD data provides centralized meteorological information for the continental United States and selected overseas locations. The maximum range of a single NEXRAD radar site is 250 nm. In addition to a wide array of services, the NEXRAD network provides important information about severe weather and air traffic safety.

NEXRAD data is not real-time. The lapsed time between collection, processing, and dissemination of NEXRAD images can be significant and may not reflect the current radar synopsis. Due to the inherent delays and the relative age of the data, it should be used for long-range planning purposes only. Never use NEXRAD data or any radar data to maneuver in or near areas of hazardous weather. Rather, use it in an early-warning capacity of pre-departure and enroute evaluation.

Composite data from all the NEXRAD radar sites in the United States is shown. This data is composed of the maximum reflectivity from the individual radar sweeps. The display of the information is color-coded to indicate the weather severity level.

The display of radar coverage is always active when NEXRAD is selected. Areas where NEXRAD radar coverage is not currently available or is not being collected are indicated in grayish-purple (Weather (WX) Page Only). Radar capability may exist in these areas, but it is not active or is off-line.

NEXRAD Abnormalities

There are possible abnormalities regarding displayed NEXRAD images. Some, but not all, of those include:

- Ground clutter
- Strokes and spurious radar data
- Sun strokes, when the radar antenna points directly at the sun
- Military aircraft deploy metallic dust (chaff) which can cause alterations in radar scans
- Interference from buildings or mountains, which may cause shadows
- Poor reception from Ground Based Transceivers (GBTs) can cause portions of the received radar imagery to not be displayed

NEXRAD Limitations

Certain limitations exist regarding the NEXRAD radar displays. Some, but not all, are listed for the user's awareness:

- NEXRAD base reflectivity does not provide sufficient information to determine cloud layers or precipitation characteristics (hail vs. rain). For example, it is not possible to distinguish between wet snow, wet hail, and rain.
- NEXRAD base reflectivity is sampled at the minimum antenna elevation angle. An individual NEXRAD site cannot depict high altitude storms at close ranges, and has no information about storms directly over the site.

NEXRAD INTENSITY

Colors are used to identify the different NEXRAD echo intensities (reflectivity) measured in dBZ (decibels of Z). "Reflectivity" (designated by the letter Z) is the amount of transmitted power returned to the radar receiver. The dBZ values increase as returned signal strength increases. Precipitation intensity is displayed using colors corresponding to the dBZ values.

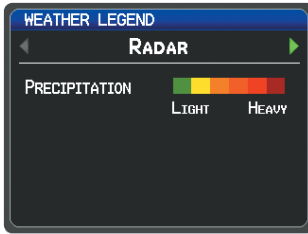

RADAR Legend

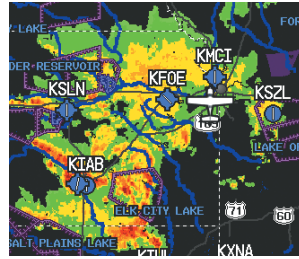

NEXRAD Data

FIS-B RADAR PRODUCTS

FIS-B weather provides two different Radar products, CONUS and Regional. The system can display each individually or a composite (COMBINED). When Regional Radar is displayed, only precipitation for your current region is displayed. The subdued (grayish-purple colored) area represents the area not covered by the regional radar product. When Combined radar data is viewed, Regional Radar data is displayed on top of CONUS data and the time shown in the lower left corner is associated with Regional Radar data only.

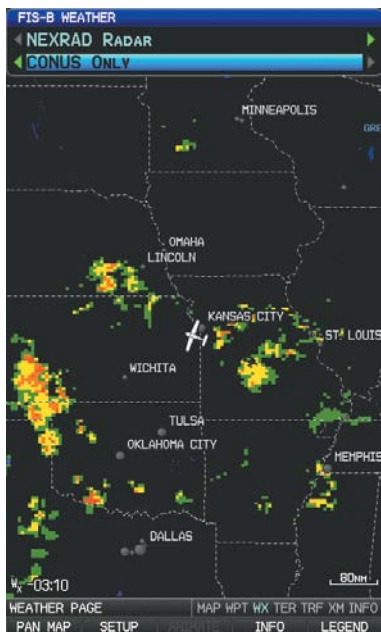

FIS-B Radar (CONUS)



FIS-B Radar (Regional)



FIS-B Radar (Combined)

WINDS ALOFT

Winds Aloft data shows the forecasted wind speed and direction in 3,000-foot increments up to 39,000 feet MSL.

The wind barbs always point in the direction that the wind is coming from. The wind speed is depicted using flags at the end of the wind barb. A short wind flag is 5 knots, a long wind flag is 10 knots, and a triangle flag is 50 knots.



Winds Aloft Data (Split-Screen)

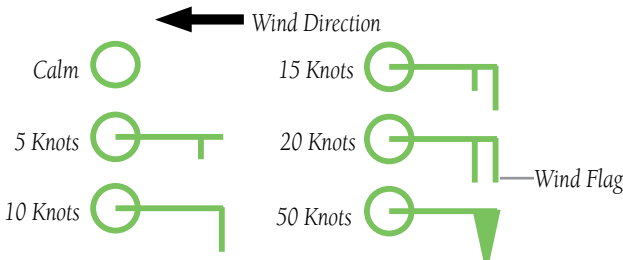

Winds Barbs

TEMPERATURES ALOFT

Temperature Aloft data shows the forecasted temperatures aloft in 3,000-foot increments up to 39,000 feet MSL. For altitudes 18,000 feet and above the relative ISA temperature is also shown. Temperatures are color coded with temperatures near and below freezing are shown as shades of blue, green for temperatures just above freezing and shades of orange are used for warmer temperatures.



Temperatures Aloft

METARS AND TAFS



NOTE: METAR information is only displayed within the installed navigation database service area.

METAR (METeoro logical Aerodrome Report) is an international code used for reporting weather observations. METARs are updated hourly or as needed. METARs typically contain information about the temperature, dewpoint, wind, precipitation, cloud cover, cloud heights, visibility, and barometric pressure. They can also contain information on precipitation amounts, lightning, and other critical data. If METAR data is available for an airport, a color-coded flag is shown next to the airport.

TAF (Terminal Area Forecast) is the standard format for 24-hour weather forecasts. TAFs may contain some of the same code as METAR data. It typically forecasts significant weather changes, temporary changes, probable changes, and expected changes in weather conditions.

METAR and TAF text data is displayed on the Map Page and the Weather (WX) Page. An abbreviated version can be viewed by panning over the METAR flag. Pressing the **ENT** Key will display additional information. METAR and TAF data can be displayed as raw or decoded text.

Changing METAR and TAF text:

- 1) Using the Map Pointer, select the desired METAR and press the **ENT** Key; or from the Waypoint (WPT) Page press the **WEATHER** Softkey. The Weather Information Page is displayed.
 - 2) Press the **MENU** Key.
 - a) Select 'Show Decoded Text' or 'Show Raw Text'.
 - b) Press the **ENT** Key.
- Or:**
- a) Select 'Change Text Size' and press the **ENT** Key.
 - b) Select 'Small', 'Medium', or 'Large' and press the **ENT** Key.

The METAR flag color is determined by the information in the METAR text.

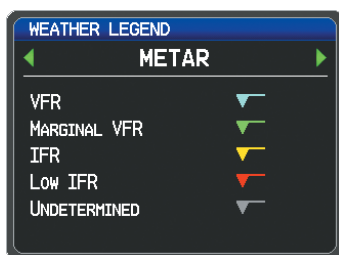

METAR Legend

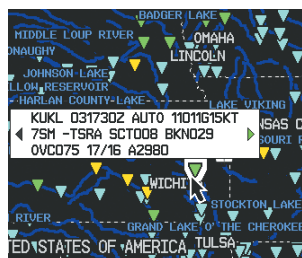

METAR Selected With Map Pointer

AIRMETS

An AIRMET (AIRmen's METeoro logical Information) can be especially helpful for pilots of light aircraft that have limited flight capability or instrumentation. An AIRMET must affect or be forecast to affect an area of at least 3,000 square miles at any one time. AIRMETS are routinely issued for six-hour periods and are amended as necessary due to changing weather conditions. AIRMETS are displayed as colored, dashed lines.

SIGMETS

A SIGMET (SIGnificant METeorological Information) advises of weather that is potentially hazardous to all aircraft. In the contiguous United States, the following items are covered: severe icing, severe or extreme turbulence, volcanic ash, dust storms, and sandstorms that lower visibility to less than three statute miles.

A Convective SIGMET is issued for the following conditions: thunderstorms, isolated severe thunderstorms, embedded thunderstorms, hail at the surface, and tornadoes.

A SIGMET is widespread and must affect or be forecast to affect an area of at least 3,000 square miles. SIGMETs are displayed as a yellow-dashed line.

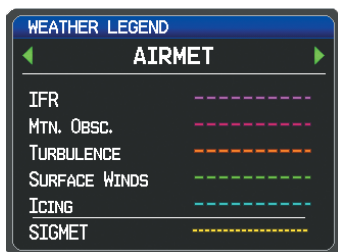

AIRMET/SIGMET Legend

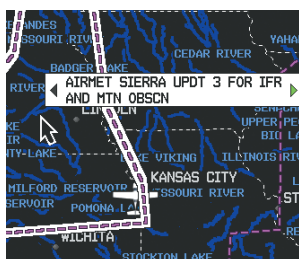

AIRMET Selected With Map Pointer

TEMPORARY FLIGHT RESTRICTIONS (TFR)



CAUTION: *The Graphical Depiction of TFR data is approximated.*



NOTE: *Do not rely solely upon data link services to provide Temporary Flight Restriction TFR information. Always confirm TFR information through official sources such as Flight Service Stations of Air Traffic Control.*

Temporary Flight Restrictions, or TFRs, temporarily restrict all aircraft from entering the selected airspace unless a waiver has been issued. TFRs are routinely issued for activities such as sporting events, dignitary visits, military depots, and forest fires. TFRs are represented as an area highlighted by red (active) or yellow (not yet active).

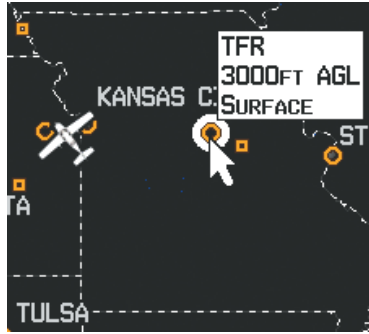

TFR Data

PIREPS

Pilot Weather Reports (PIREPs) provide timely weather information. When significant weather conditions are reported or forecast, Air Traffic Control (ATC) facilities are required to solicit PIREPs. A PIREP may contain unforecast adverse weather conditions, such as low in-flight visibility, icing conditions, wind shear, and turbulence. PIREPs are issued as either Routine (UA) (blue) or Urgent (UUA) (yellow).

PIREP text is displayed on the Weather (WX) Page. An abbreviated version can be viewed by panning over the PIREP box. Using the Map Pointer, highlight the desired PIREP and press the **ENT** Key to display the decoded text.



PIREP Data

USING FIS-B WEATHER PRODUCTS



WARNING: Do not use data link weather information for maneuvering in, near, or around areas of hazardous weather. Information contained with in data link weather products may not accurately depict current weather conditions.



WARNING: Do not use the indicated data link weather product age to determine the age of the weather information shown by the data link weather product. Due to time delays inherent in gathering and processing weather data for data link transmission, the weather information shown by the data link weather product may be significantly older than the indicated weather product age.

FIS-B Weather Products can be displayed on the Map Page and individually on the Weather (WX) Page.

Switching Weather Sources:

- 1) Press the **MENU** Key twice to display the Main Menu.
- 2) Turn or move the **FMS** Joystick to highlight 'System Setup...' and press the **ENT** Key.
- 3) Turn or move the **FMS** Joystick to highlight 'WEATHER'.
- 4) Press the **ENT** Key.
- 5) Turn or move the **FMS** Joystick to select the desired weather source (AUTO, XM, or GDL FIS-B). The default is 'AUTO' which will use XM over GDL FIS-B if both are available.
- 6) Press the **FMS** Joystick, the **CLR** Key, or the **EXIT** Softkey to return to the previous page.

Or

- 1) From the Weather Page press **SETUP** Softkey.
- 2) Turn or move the **FMS** Joystick to select the desired weather source (AUTO, XM, or GDL FIS-B). The default is 'AUTO' which will use XM over GDL FIS-B if both are available.
- 3) Press the **FMS** Joystick, the **CLR** Key, or the **EXIT** Softkey to return to the previous page

The setup menu for the Map Page controls the map range settings above which weather products are decluttered from the display. If a map range larger than the weather product map range setting is selected, the weather product data is removed from the map. The menu also provides a means for enabling/disabling display of 'Airmets', 'Sigmet's', 'Weather Data', and/or 'NEXRAD' on the Map Page.

Additional information about the following can be displayed by panning over the display on the Weather Page or the Map Page:

- SIGMETs
- METARs
- AIRMETs
- TFRs

Additional information is also available for PIREPs on the Weather Page (not displayed on the Map Page):

Viewing FIS-B Weather products on the Map Page:

- 1) Select the Map Page.
- 2) Select the **WEATHER** Softkey to display the FIS-B weather products.
Or:
 - a) Press the **MENU** Key.
 - b) Select 'Show Weather' and press the **ENT** Key.
- 3) Press the **FMS** Joystick to activate the Map Pointer.
- 4) Use the **FMS** Joystick to highlight the desired weather product with the Map Pointer.
- 5) With the desired weather product highlighted, press the **ENT** Key to get detailed information (if available).

Viewing FIS-B Weather products on the Weather (WX) Page:

- 1) From the WX Page press the **FMS** Joystick to highlight the weather product field.
- 2) Turn the **FMS** Joystick to select and automatically display the desired weather product.
- 3) If necessary, move the **FMS** Joystick to highlight the type field and turn the **FMS** Joystick to scroll through a list of available options.
- 4) Press the **PAN MAP** Softkey to get abbreviated information about the selected weather product or map feature (if available).

- With the desired weather product selected press the **ENT** Key to get detailed information (if available).

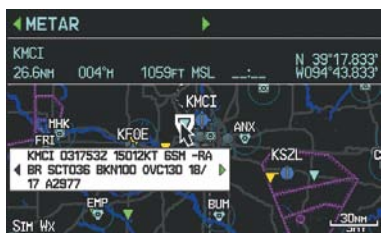

Abbreviated Product Info (Split-Screen)



Detailed Product Info (Split-Screen)

Setting up and customizing weather data for the Map Page:

- From the Map Page press the **MENU** Key.
- Turn or move the **FMS** Joystick to highlight 'Set Up Map' and press the **ENT** Key.
- Turn the **FMS** Joystick to select the 'FIS-B Weather' Category from the horizontal list.
- Move the **FMS** Joystick to select the desired weather product.
- Turn the **FMS** Joystick to access a list of options for each product (On/Off, Auto, range settings).
- Press the **ENT** Key to select an option.
- Press the **FMS** Joystick, the **CLR** Key, or the **EXIT** Softkey to return to the Map Page with the changed settings.

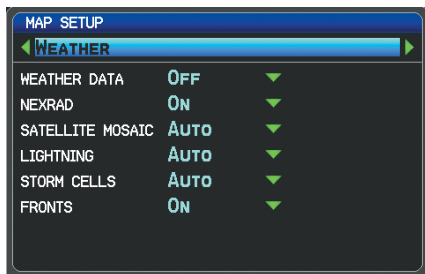

Map Setup Page (Weather Category)



Map Setup Page (WX Report Category)

Restoring default weather data for the Map Page:

- 1) From the Map Page press the **MENU** Key.
- 2) Turn or move the **FMS** Joystick to highlight 'Set Up Map' and press the **ENT** Key.
- 3) Turn the **FMS** Joystick to select 'FIS-B Weather'.
- 4) Move the **FMS** Joystick to select the desired weather product.
- 5) Press the **MENU** Key.
- 6) With 'Restore Default' or 'Restore All Map Defaults' selected, press the **ENT** Key.
- 7) Press the **FMS** Joystick, the **CLR** Key, or the **EXIT** Softkey to return to the Map Page with the restored settings.

Viewing legends for displayed weather products:

- 1) From the Map Page press the **MENU** Key to access the Map Page Menu.
- 2) Turn or move the **FMS** Joystick to select 'Weather Legend' and press the **ENT** Key to display the Weather Legend Window.
- 3) Turn the **FMS** Joystick to view the desired weather legend (Radar, Fronts, METAR, AIRMET, Turbulence Forecast, Icing Forecast, or Other).
- 4) With '**DONE**' highlighted, press the **ENT** Key to return to the Map Page.

Or:

- 1) From the Weather (WX) Page press the **LEGEND** Softkey to display the Weather Legend Window.
- 2) Turn the **FMS** Joystick to view the desired weather legend (Radar, Fronts, METAR, AIRMET, Turbulence Forecast, Icing Forecast, or Other).
- 3) Press the **FMS** Joystick, **CLR** Key, or **LEGEND** Softkey to return to the Weather (WX) Page.

Animating FIS-B weather:

- 1) From the Map Page press the **MENU** Key to access the Map Page Menu.
- 2) Turn or move the **FMS** Joystick to select 'Animate Weather' and press the **ENT** Key.
- 3) To stop animation, press the **MENU** Key again, turn or move the **FMS** Joystick to select 'Stop Animation', and press the **ENT** Key.

Or:

- 1) Select the Weather (WX) Page.
- 2) Using the **FMS** Joystick select either the 'NEXRAD Radar' or 'Satellite Mosaic' weather product.
- 3) Select the **ANIMATE** Softkey to begin animation.

Or:

- a) Press the **MENU** Key.
 - b) Select 'Animate Weather' and press the **ENT** Key to begin animation.
- 4) To stop animation, deselect the **ANIMATE** Softkey.

Or:

Press the **MENU** Key, turn or move the **FMS** Joystick to select 'Stop Animation', and press the **ENT** Key.

Viewing FIS-B NOTAMS:

- 1) From the Waypoints Page press **NOTAMS** Softkey.
- 2) If needed, scroll up or down using the **FMS** Joystick.

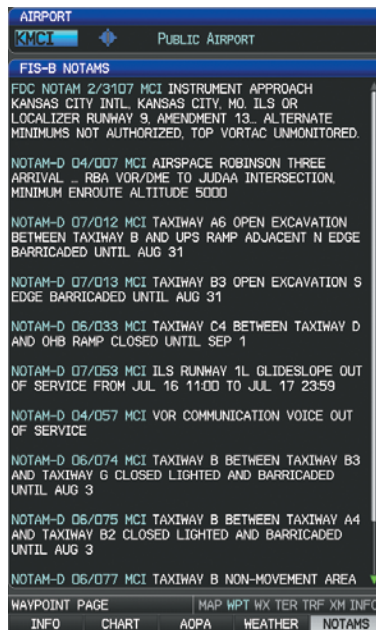

NOTAMS Information Page

4.2 TERRAIN



WARNING: Do not use Terrain information for primary terrain avoidance. Terrain information is intended only to enhance situational awareness.



NOTE: Terrain data is not displayed when the aircraft is outside the installed terrain database coverage area.



NOTE: Terrain depicted in the Profile View is always “ahead” of the aircraft, and will change as ground track changes.

The Terrain Page displays altitudes of terrain and obstructions relative to the aircraft position and altitude with reference to a database that may contain inaccuracies. Terrain and obstructions are shown only if they are in the database. Terrain and obstacle information should be used as an aid to situational awareness. They should never be used to navigate or maneuver around terrain.

Note that all obstructions may not be available in the terrain and obstacle database. No terrain and obstacle information is shown without a valid 3-D GPS position.

The GPSMAP 695/696 GPS receiver provides the horizontal position and altitude of the aircraft. Aircraft GPS altitude is derived from satellite position. GPS altitude is then converted to a mean sea level (MSL)-based altitude (GPS-MSL altitude) and is used to determine terrain and obstacle proximity. GPS-MSL altitude accuracy is affected by satellite geometry, but is not subject to variations in pressure and temperature that normally affect pressure altitude sensors. GPS-MSL altitude does not require local altimeter settings to determine MSL altitude. It is a widely-used MSL altitude source.

Terrain and obstacle databases are referenced to MSL. Using the GPS position and altitude, the Terrain feature portrays a 2-D picture of the surrounding terrain and obstacles relative to the position and altitude of the aircraft. GPS position and GPS-MSL altitude are used to calculate and predict the aircraft’s flight path in relation to the surrounding terrain and obstacles. In this way, the pilot can view predicted dangerous terrain and obstacle conditions.

Alert windows appear on all pages (except the Terrain (TER) Page) to inform the pilot of proximity to the terrain and obstacles, as well as an unsafe descent rate. These alerts depend on user-defined parameters in the Terrain Page setup.

TERRAIN INFORMATION

Two views are displayed on the Terrain (TER) Page: the Map View, and the Profile View. The areas of the terrain shaded red are predicted to be within 100 feet below or above the aircraft. The yellow terrain areas are between the user-defined Caution Elevation and 100 feet below the aircraft. By default, the Caution Elevation is 1,000 feet; therefore, the areas in yellow are between 1,000 feet and 100 feet below the aircraft. The black areas are further than the Caution Elevation. A projected point of impact is marked with an "X" symbol.

OBSTACLE INFORMATION

Obstacles are shown on the Terrain Page at or below the map range of 12 nm. Obstacles are also shown on the Map Page when the map range is set to 3 nm or below.

Standard aeronautical chart symbols are used for lighted or unlighted obstacles taller than 200 feet Above Ground Level (AGL). Refer to the Obstacle Icons legend below.

Each obstacle is labeled with the altitude of the top of the obstacle, or Mean Sea Level (MSL). Each obstacle also lists, in parentheses, the actual height of the obstacle, or Above Ground Level (AGL).

Unlighted Obstacle		Lighted Obstacle		Potential Impact Points	Obstacle Location
< 1000' AGL	> 1000' AGL	< 1000' AGL	> 1000' AGL		
					WARNING: Red obstacle is above or within 100' below current aircraft altitude
					CAUTION: Yellow obstacle is between 100' and 1000' below current aircraft altitude

Terrain Obstacle Colors and Symbology

TERRAIN AND OBSTACLE COLOR CODE

Red—terrain or obstacle is within 100 feet above or below the aircraft.

Yellow—terrain or obstacle is between the user-defined Caution Elevation and 100 feet below the aircraft.

Enabling/Disabling Terrain Shading on the Map Page:

From the Map Page with the VFR Map displayed, press the **TERRAIN** Softkey.

Or:

- 1) From the Map Page, press the **MENU** Key.
- 2) Turn or move the **FMS** Joystick to highlight 'Set Up Map', and press the **ENT** Key.
- 3) Turn the **FMS** Joystick to highlight the 'Map' Category from the horizontal list.
- 4) Move the **FMS** Joystick to highlight the 'Terrain Shading' field.
- 5) Turn the **FMS** Joystick to select 'On' or 'Off', and press the **ENT** Key.

TERRAIN SETTINGS

Use the terrain settings to set levels for terrain alerts as well as obstacles in or near your flight path.

- Caution Elevation—The GPSMAP 695/696 will provide an alert if the terrain or obstacle is within the default Caution Elevation or user-defined Caution Elevation.
- Look Ahead Time—Determines the maximum time when an alert annunciation occurs. For example, if 120 seconds is selected, the GPSMAP 695/696 provides an alert up to 120 seconds before you reach the terrain or obstacle.
- Alert Sensitivity—The three Alert Sensitivity settings (Terrain, Obstacle, and Descent Rate) determine what level of alerts are annunciated. The GPSMAP 695/696 defaults to 'High' sensitivity, which annunciates all red and yellow alerts at the time set in Look Ahead Time. 'Medium' sensitivity annunciates all of the red and the highest priority of yellow alerts. 'Low' only annunciates red alerts. 'Off' disables the alert.

Accessing the terrain settings:

- 1) On the Terrain Page, press the **SETTINGS** Softkey.
- 2) Move the **FMS** Joystick to highlight the desired field.
- 3) Turn the **FMS** Joystick to make changes to the highlighted field.
- 4) With 'Done' highlighted press the **ENT** Key, or press the **CLR** Key to accept the changes and exit the Terrain Setup window.

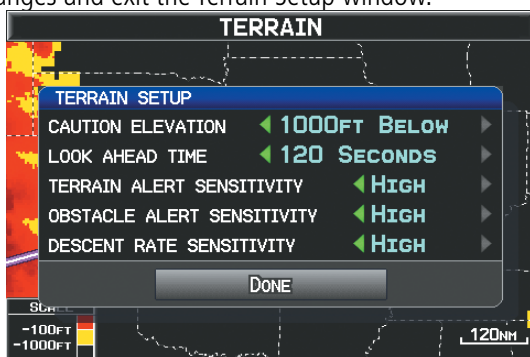

Terrain Setup

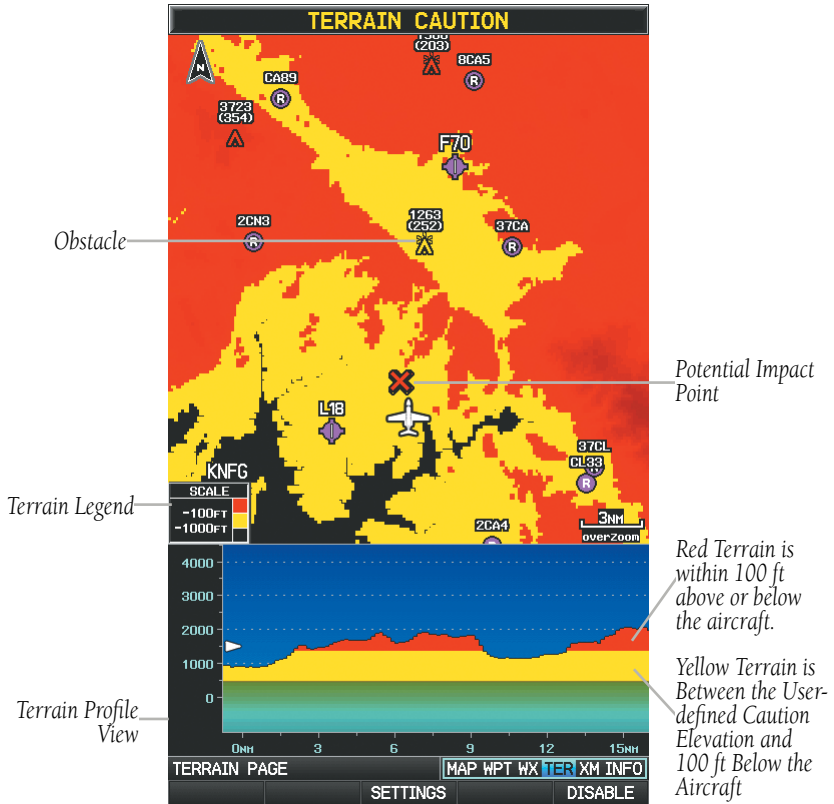

Terrain Page

Setting up the Terrain Page:

- 1) On the Terrain Page, press **MENU** to access the Page Menu.
- 2) Turn or move the **FMS** Joystick to highlight 'Set Up Terrain' and press the **ENT** Key.
- 3) Move the **FMS** Joystick to highlight the desired field.
- 4) Turn the **FMS** Joystick to make changes to the highlighted field.
- 5) With 'Done' highlighted press the **ENT** Key, or press the **CLR** Key to accept the changes and exit the Terrain Setup window.

Overview

GPS Navigation

Flight Planning

Hazard Avoidance

Additional Features

Appendices

Index

TERRAIN ALERTS

Terrain, Obstacle, and Descent Rate Alerts are issued when flight conditions meet parameters that are set within the software algorithms. Terrain alerts typically employ a CAUTION or a WARNING alert severity level, or both. When an alert is issued, visual annunciations are displayed and aural alerts are simultaneously issued. When the aircraft descends through 500 feet above the destination airport an audible “Five Hundred” altitude reminder occurs.

If the Terrain Page is not displayed, a pop-up alert appears in the lower left corner of the page. The Range Rings on the pop-up alert are spaced every whole mile/kilometer/nautical mile. Press the **CLR** Key to acknowledge the pop-up and/or aural alert.

Enabling/Disabling terrain alerts:

From the Terrain Page, press the **DISABLE** Softkey.

Or:

- 1) From the Terrain Page, press the **MENU** Key to access the Page Menu.
- 2) Turn or move the **FMS** Joystick to highlight ‘Disable Alerts’ or ‘Enable Alerts’ and press the **ENT** Key. Disabling terrain alerts is only temporary. Terrain alerts are automatically enabled when the unit is powered on.

AURAL ALERTS

- “Five Hundred”—when the aircraft descends through 500 feet above the destination airport.

The following aural terrain alerts are issued when flight conditions meet parameters that are set within the software algorithms, and are dependant on the sensitivity level set in the Terrain Setup Menu.

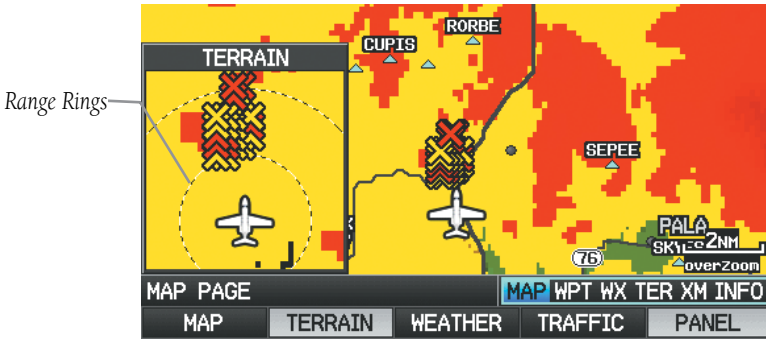

Pop-Up Alert (Map Page)

Alert Severity	Terrain	Obstacle	Descent Rate
Caution	"caution, terrain" "caution, terrain ahead"	"caution, obstacle" "caution, obstacle ahead"	"caution, sink rate"
Warning	"terrain ahead! pull up!" "terrain! terrain! pull up! pull up!"	"obstacle ahead! pull up!" "obstacle! obstacle! pull up! pull up!"	"sink rate, pull up!" "pull up!"

Aural Alerts

Enabling/Disabling Terrain Audio:

- 1) Press the **Menu** Key twice to display the Main Menu
- 2) Move the **FMS** Joystick to select 'System Setup...' and press the **ENT** Key.
- 3) Move the **FMS** Joystick to select 'Sound', and press the **ENT** Key.
- 4) Move the **FMS** Joystick to highlight the 'Terrain Audio' field.
- 5) Turn the **FMS** Joystick to select 'On' or 'Off', and press the **ENT** Key.



4.3 TRAFFIC INFORMATION

TRAFFIC SOURCE

The GPSMAP 695/696 is compatible with two different traffic sources; TIS-A traffic via a Garmin Mode S Transponder (GTX 330), or ADS-B/TIS-B traffic via a GDL 39. When the GPSMAP 696 is configured with both a Mode S transponder capable of receiving TIS-A traffic and a GDL 39 capable of receiving ADS-B/TIS-B traffic the GPSMAP 695/696 will automatically switch between traffic sources. When both options are configured, the Serial Pass-Through capabilities of the GDL 39 will need to be configured, see Appendix D for configuration information. The following conditions describe the traffic display logic.

- If the GTX is not receiving TIS-A traffic data, GDL 39 ADS-B traffic will be displayed.
- If the GDL 39 is receiving both air-to-air ADS-B traffic data and ground uplink TIS-B traffic, then the GDL 39 ADS-B traffic will be displayed.
- If the GTX is receiving TIS-A traffic, and the GDL 39 is not receiving ground uplink TIS-B traffic, then GTX TIS-A traffic will be displayed.

If more than one traffic source is configured, the current traffic source is annunciated in the upper left hand corner of the Traffic Page (TRF).

Traffic Source	Description
	Displaying TIS-A traffic from a Mode S transponder.
	Displaying ADS-B/TIS-B traffic from a GDL 39

Traffic Source Annunciation

TRAFFIC INFORMATION SERVICE (TIS-A)





NOTE: Refer to Appendix E for general information regarding TIS-A. Refer to Appendix D for configuration information.

The GPSMAP 695/696 supports TIS-A input from a Garmin Mode S transponder, such as the GTX 330.

SYSTEM STATUS

The traffic system status is annunciated in the upper right corner of the Map Page.

System Status	Traffic Icon
Operating	
No Traffic Data Available	



If a Traffic Icon is not displayed, check the Map Page range and/or the Traffic Display Range on the Map Set Up menu.

Traffic Modes

If a Traffic Icon is not displayed, check the Map Page Range and/or the Traffic Display Range on the Map Setup Menu.

TIS-A SYMBOLOGY

TIS-A traffic is shown on the GPSMAP 695/696 graphically shown on the Map Page, and in the Traffic Warning Window. A Traffic Advisory (TA) symbol appears as a solid yellow circle. All other traffic is shown as a hollow white diamond. Altitude deviation from own aircraft altitude is shown above the target symbol if traffic is above own aircraft altitude, and below the symbol if they are below own aircraft altitude. Altitude trend is shown as an up arrow (>+500 ft/min), down arrow (<-500 ft/min), or no symbol if less than 500 ft/min rate in either direction.

TIS-A Symbol	Description
	Traffic Advisory (TA)
	Other Traffic

TIS-A Traffic Symbols

TIS-A ALERTS

A TIS-A audio alert is generated whenever the number of Traffic Advisories on the GPSMAP 695/696 screen increases from one scan to the next. Limiting Traffic Advisories only reduces the “nuisance” alerting due to proximate aircraft. For example, when the first Traffic Advisories appear on the TIS-A display, the user is alerted audibly. So long as a single aircraft remains on the TIS-A display, no further audio alert is generated. If a second (or more) aircraft appears on the screen, a new audio alert is sounded.

If the number of Traffic Advisories on the TIS-A display decreases and then increases, a new audio alert is sounded. The TIS-A audio alert is also generated whenever TIS-A service becomes available. The following TIS-A audio alerts are available:

- “Traffic”—TIS-A traffic alert received.
- “Traffic Not Available”—TIS-A service is not available or out of range.

Adjusting alert volume:

- 1) Press the **MENU** Key twice to access the Main Menu.
- 2) Turn or move the **FMS** Joystick to highlight ‘System Setup’, and press the **ENT** Key.
- 3) Turn or move the **FMS** Joystick to highlight ‘Sound’, and press the **ENT** Key.
- 4) Move the **FMS** Joystick to highlight the ‘Alert Volume’ field.
- 5) Turn the **FMS** Joystick to select the desired volume (0-10).
- 6) Press the **EXIT** Softkey or **FMS** Joystick to exit.

TRAFFIC WARNING WINDOW

The system displays the Traffic Warning Window when the system issues a traffic advisory (TA). The Traffic Warning Window shows a small pop-up map in the lower left corner. The Range Rings on the pop-up alert are spaced every whole mile/kilometer/nautical mile. Press the **CLR** Key to remove the Traffic Warning Window.



NOTE: *The Traffic Warning Window is disabled when the aircraft ground speed is less than 30 knots or when on the approach leg of a route.*

TRAFFIC GROUND TRACK

Traffic ground track is indicated on the GPSMAP 695/696 screen by a "target track vector," a short line shown in 45-degree increments, extending in the direction of target movement.

DISPLAYING TRAFFIC DATA

TIS-A traffic can be displayed on the Map Page.

Setting up and customizing TIS-A traffic on the map page:

From the Map Page press the **TRAFFIC** Softkey to toggle traffic on/off.

Or:

- 1) From the Map Page press the **MENU** Key.
- 2) Turn or move the **FMS** Joystick to highlight 'Set Up Map' and press the **ENT** Key.
- 3) Turn the **FMS** Joystick to select the 'Map' Category from the horizontal list.
- 4) Move the **FMS** Joystick to highlight the 'TRAFFIC DATA' Field.
- 5) Turn the **FMS** Joystick to access a list of options for each feature (On/Off).
- 6) Using the **FMS** Joystick select the desired option and press the **ENT** Key.
- 7) Press the **FMS** Joystick, the **CLR** Key, or the **EXIT** Softkey to return to the Map Page with the changed settings.

Displaying TIS-A information using the Map Pointer:

- 1) With traffic displayed on the Map Page, press the **FMS** Joystick. The Map Pointer is activated.
- 2) Move the **FMS** Joystick to highlight the desired traffic.

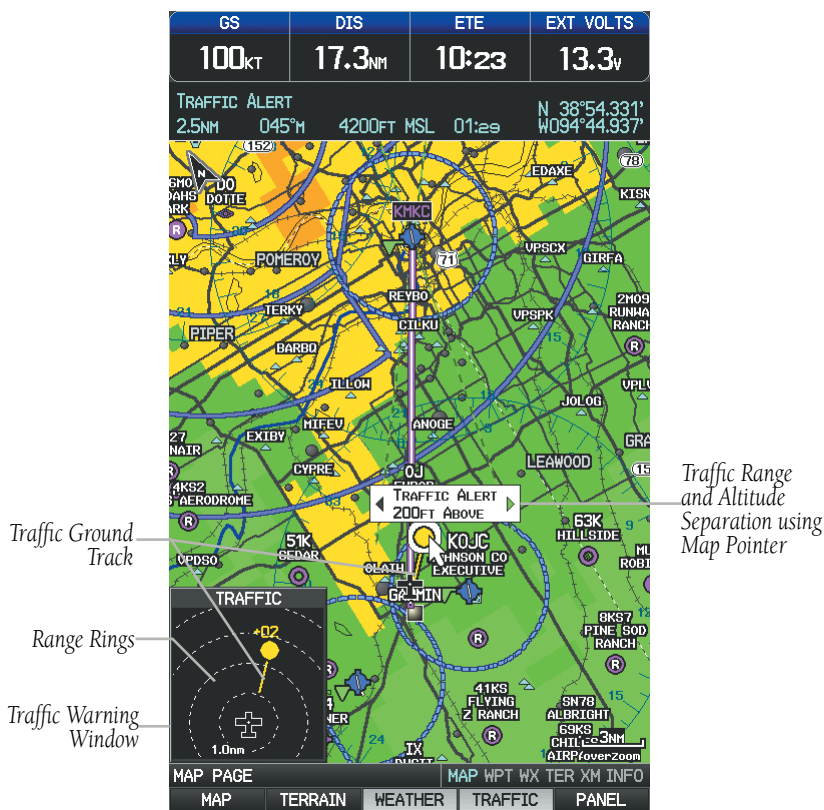

TIS-A (Map Page)

DATA LINK TRAFFIC (GDL 39)

The GDL 39 is a receive-only data link radio with on-board GPS, 978 MHz (Universal Access Transceiver frequency band), and 1090 MHz Extended Squitter (1090 ES) receivers. It is designed to receive, process, and output traffic (ADS-B air-to-air, and TIS-B traffic information), and weather (Flight Information Service-Broadcast (FIS-B)) information to the GPSMAP 695/696 through a power/data cable.

ADS-B (Automatic Dependent Surveillance-Broadcast) is a surveillance technology deployed across the United States as the cornerstone of the FAA's Next Generation Air Transportation System (NextGen). ADS-B enables improved surveillance services, both air-to-air and air-to-ground, especially in areas where radar is ineffective due to terrain or where it is impractical or cost prohibitive. Initial applications of air-to-air ADS-B are for "advisory" use only, enhancing a pilot's visual acquisition of other nearby ADS-B equipped aircraft either when airborne or on the airport surface.

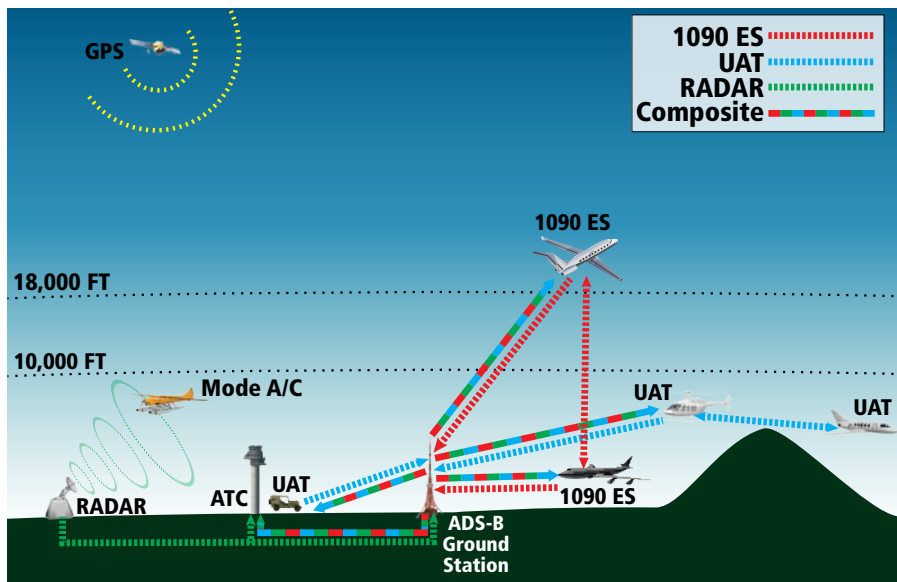

ADS-B System

For the purpose of distinguishing between levels of ADS-B service, there are three classifications of aircraft or system capability; ADS-B In, ADS-B Out, and ADS-B participating. ADS-B In refers to the capability to receive ADS-B information. ADS-B Out refers to the capability to transmit ADS-B information. ADS-B participating refers

to the capability to both send and receive ADS-B information. Aircraft lacking either ADS-In, ADS-B Out, or both ADS-B capabilities may also be referred to as ADS-B non-participating aircraft.

Currently, rule-compliant ADS-B Out capability in the United States requires a TSO'ed SBAS-enabled GPS, such as a Garmin GPS 400W or similar, and one of two possible data links: 1090 ES transponder or a 978 MHz UAT. Either data link system is capable of transmitting the aircraft's position, velocity, identification, and other information every second to compatible aircraft and ground stations called Ground Based Transceivers (GBTs).

Because 1090 ES transponders and UATs operate on different frequencies, aircraft not similarly equipped cannot transmit/receive data link information directly to/from each other. Instead, operation within range of a GBT is required to receive data link information on both frequencies. The GDL 39 is unique in its ADS-B In capability since it can receive data link information from both 1090 ES transponders and UATs.

Thus, the GDL 39 receives traffic information directly from any ADS-B Out aircraft within range as well as the rebroadcast of ADS-B information from any nearby GBT. This rebroadcast is called Automatic Dependent Surveillance-Rebroadcast (ADS-R) and is automatically triggered by the detection of an ADS-B participating aircraft within the service volume of the GBT. As a 978 MHz (UAT frequency) receiver, the GDL 39 can receive both the Traffic Information Service-Broadcast (TIS-B) and Flight Information Service-Broadcast (FIS-B) provided in conjunction with ADS-R services when in range of a GBT.

FIS-B service is provided continuously, but ADS-R including TIS-B will only be broadcast by a GBT when an ADS-B participating aircraft is within the GBT's defined service volume. In this case, a GBT will only rebroadcast TIS-B information relative to the ADS-B participating aircraft. **Only traffic that is within 15 nm lateral and 3,500' vertical of the ADS-B participating aircraft is provided in the broadcast.** Non-participating traffic aircraft located farther than 15 nm laterally and 3,500' vertically from the participating aircraft are excluded from the information transmitted by the GBT.

TIS-B traffic information includes non-participating aircraft detected by ATC surveillance radar. As TIS-B data is derived from ATC surveillance radar data, TIS-B traffic position updates typically occur every three to thirteen seconds. **Therefore,**

TIS-B traffic may be displayed with degraded positional accuracy. Aircraft without operating transponders are invisible to TIS-B. Aircraft operating outside of the ATC radar coverage area are also not displayed.

Since the GDL 39 is a receive-only device, even when used onboard an aircraft equipped with a qualifying GPS and 1090 ES transponder, a GBT may not identify it as an ADS-B participating aircraft. The squitter of some 1090 ES transponders, including the Garmin GTX 330, must be configured to communicate that the aircraft has 978 MHz receive capability in order to be identified as an ADS-B participating aircraft.



WARNING: Do not rely solely upon the display of traffic information for collision avoidance maneuvering. The traffic display does not provide collision avoidance resolution advisories and does not, under any circumstances or conditions, relieve the pilot's responsibility to see and avoid other aircraft.





WARNING: Do not rely solely upon the display of traffic information to accurately depict all of the traffic within range of the aircraft. Due to lack of equipment, poor signal reception, and/or inaccurate information from aircraft or ground stations, traffic may be present that is not represented on the display.

Viewing GDL 39 Traffic and Weather Status:

- 1) Press the **MENU** Key twice to display the Main Menu.
 - 2) Turn or move the **FMS** Joystick to highlight 'Data Link' and press the **ENT** Key.
- Or**
- 1) From the dedicated Traffic Page (TRF) or Weather Page (WX) select the **INFO** Softkey.

SYSTEM STATUS

The traffic system status is announced in the upper right corner of the Map Page.

System Status	Traffic Icon
Full traffic services available for an ADS-B participating aircraft (ground linked TIS-B, FIS-B and ADS-R, and Air-to-Air ADS-B). If you are using the GDL 39 on a non-participating aircraft you may still see this when you are within the service area of any participating aircraft. As a non-participating aircraft you are only receiving TIS-B traffic information for traffic within 15 nm and 3,500' of a participating aircraft.	
Limited traffic services available (may be limited to Air-to-Air ADS-B)	
No Traffic Data Available	

ADS-B Traffic Modes







The GDL 39 also has a pressure altitude sensor to aid in displaying the relative altitude of received traffic information. If the GDL 39 is used onboard a pressurized aircraft, the pressure altitude sensor should be turned off.

Configuring the GDL 39 for a Pressurized or Non-Pressurized Aircraft:

- 1) Press the **MENU** Key twice to display the Main Menu.
- 2) Turn or move the **FMS** Joystick to highlight 'Data Link' and press the **ENT** Key.
- 3) Select the **SETUP** Softkey.
- 4) Turn or move the **FMS** Joystick to select Aircraft Type (i.e., PRESSURIZED or NOT PRESSURIZED).
- 5) Press the **EXIT** Softkey or **FMS** Joystick to exit.

TRAFFIC DESCRIPTION

ADS-B traffic operation is similar other traffic systems, but ADS-B adds additional symbology. The symbols used to display ADS-B traffic are shown in the table below. The traffic identifier and altitude are displayed below the traffic symbol. A small up or down arrow next to the traffic symbol indicates that the traffic is climbing or descending at a rate of at least 500 feet per minute. The vector line that extends from the traffic symbol is an indication of the intruder aircraft track. For directional traffic symbols, the arrow head points in the direction of aircraft's ground track.

Symbol	Description
	Non-threat, non-directional airborne traffic
	Non-threat directional airborne Traffic with track vector. Points in the direction of the aircraft track.
	Non-directional airborne Proximity Advisory (PA). Proximity Advisories are issued for any traffic within 6 nautical miles and +/- 1,200'.
	Directional airborne Proximity Advisory (PA) with track vector. Points in the direction of the aircraft track. Proximity Advisories are issued for any traffic within 6 nautical miles and +/- 1,200'.
	Non-directional airborne Traffic Advisory (TA)
	Non-directional off-scale airborne Traffic Advisory (TA). Displayed at outer range ring at proper bearing.

	Directional airborne Traffic Advisory (TA) with track vector. Points in the direction of the aircraft track.
	Directional off-scale airborne Traffic Advisory (TA). Points in the direction of the aircraft track.
	*Ground traffic without directional information. Ground traffic is only displayed when own aircraft is below 1,500 feet AGL or on the ground.
	*Directional surface traffic. Ground traffic is only displayed when own aircraft is below 1,500 feet AGL or on the ground.
	*Non-directional non-aircraft ground traffic. Ground traffic is only displayed when own aircraft is below 1,500 feet AGL or on the ground.
	*Directional non-aircraft ground traffic. Ground traffic is only displayed when own aircraft is below 1,500 feet AGL or on the ground.
*Ground traffic is only displayed on the Map Page when the aircraft is on the ground or below 1,500 feet AGL. Ground traffic is always displayed on the dedicated traffic page.	

ADS-B Traffic Symbology

TRAFFIC ADVISORIES (TA)

The GDL 39 automatically adjusts its Traffic Advisory (TA) sensitivity level to reduce the likelihood of nuisance TA alerts during various phases of flight. TAs are issued for traffic when they are predicted to be within a specified volume of airspace around your aircraft in a specified amount of time. The protected volume and time interval varies based on the current geodetic altitude and groundspeed. Thus, the protected volume of airspace increases with altitude and ground speed. Refer to the following table for details.

Altitude (Geodetic)	Look Ahead Time (sec.)	Vertical Separation (ft.)	Horizontal Separation (nm.)
Below 5,000	30	+/-850	.35
5,000-10,000	40	+/-850	.55
10,000-20,000	45	+/-850	.80
20,000-42,000	48	+/-850	1.10
Above 42,000	48	+/-1,200	1.10

Traffic Advisories

TRAFFIC ALERTS (ADS-B TIS-B)

A traffic audio alert is generated whenever the number of Traffic Advisories on the GPSMAP 695/696 display increases. Limiting Traffic Advisories only reduces the “nuisance” alerting due to proximate aircraft. For example, when the first Traffic Advisories appear on the display, the user is alerted audibly. So long as a single aircraft remains on the display, no further audio alert is generated. If a second (or more) aircraft appears on the screen, a new audio alert is sounded. Traffic Advisories can only be issued when the GDL 39 knows its own altitude and the altitude of the intruder aircraft.

If the number of Traffic Advisories on the traffic display decreases and then increases, a new audio alert is sounded. The traffic audio alert is also generated whenever TIS-B service becomes available. The traffic audio alerts are as follows:

- “Traffic”—TIS-B/ADS-B traffic alert received.
- “Traffic Not Available”—TIS-B/ADS-B service is not available or out of range.

Disabling/Enabling the traffic alerts:



NOTE: Traffic alerts are reset to ‘enabled’ on the next power cycle.

- 1) From the Traffic (TRF) Page press the **DISABLE** Softkey to enable/disable traffic alerts.

Adjusting alert volume:

- 1) Press the **MENU** Key twice to access the Main Menu.
- 2) Turn or move the **FMS** Joystick to highlight ‘System Setup’, and press the **ENT** Key.
- 3) Turn or move the **FMS** Joystick to highlight ‘Sound’, and press the **ENT** Key.
- 4) Move the **FMS** Joystick to highlight the ‘Alert Volume’ field.
- 5) Turn the **FMS** Joystick to select the desired volume (0-10).
- 6) Press the **EXIT** Softkey or **FMS** Joystick to exit.

TRAFFIC WARNING WINDOW

The system displays the Traffic Warning Window when the GDL 39 issues a traffic advisory (TA). The Traffic Warning Window is a small pop-up map in the lower left corner. The Range Rings on the pop-up alert are spaced every whole mile/kilometer/nautical mile. Press the **CLR** Key to remove the Traffic Warning Window.

DISPLAYING TRAFFIC DATA

Traffic is displayed by default on the Map Page and in the Traffic Warning Window. Traffic Symbol and Traffic Label (i.e., relative altitude, altitude trend and absolute motion vectors) settings selects the maximum range at which traffic labels or symbols are shown. Traffic Labels can also be turned off.

Enabling/disabling traffic data on the Map Page:

1) Press the **TRAFFIC** Softkey.

Or:

- 1) From the Map Page, press the **MENU** Key.
- 2) Turn or move the **FMS** Joystick to highlight 'Set Up Map', and press the **ENT** Key.
- 3) If necessary, turn the **FMS** Joystick to highlight the 'Traffic' Category from the horizontal list.
- 4) Move the **FMS** Joystick to highlight 'Traffic Data'.
- 5) Turn the **FMS** Joystick to select 'ON/OFF' and press the **ENT** Key.

Customizing traffic data on the Map Page:

- 1) From the Map Page, press the **MENU** Key.
- 2) Turn or move the **FMS** Joystick to highlight 'Set Up Map', and press the **ENT** Key.
- 3) If necessary, turn the **FMS** Joystick to highlight the 'Traffic' Category from the horizontal list.
- 4) Move the **FMS** Joystick to highlight 'Traffic Symbol', or 'Traffic Label' field.
- 5) Turn the **FMS** Joystick to select 'OFF', 'AUTO' or range settings for Traffic Symbol and Traffic Label, and press the **ENT** Key.

Displaying Traffic information using the map pointer:

- 1) With traffic displayed on the Map Page, press the **FMS** Joystick. The Map Pointer is activated.
- 2) Move the **FMS** Joystick to highlight the desired traffic.

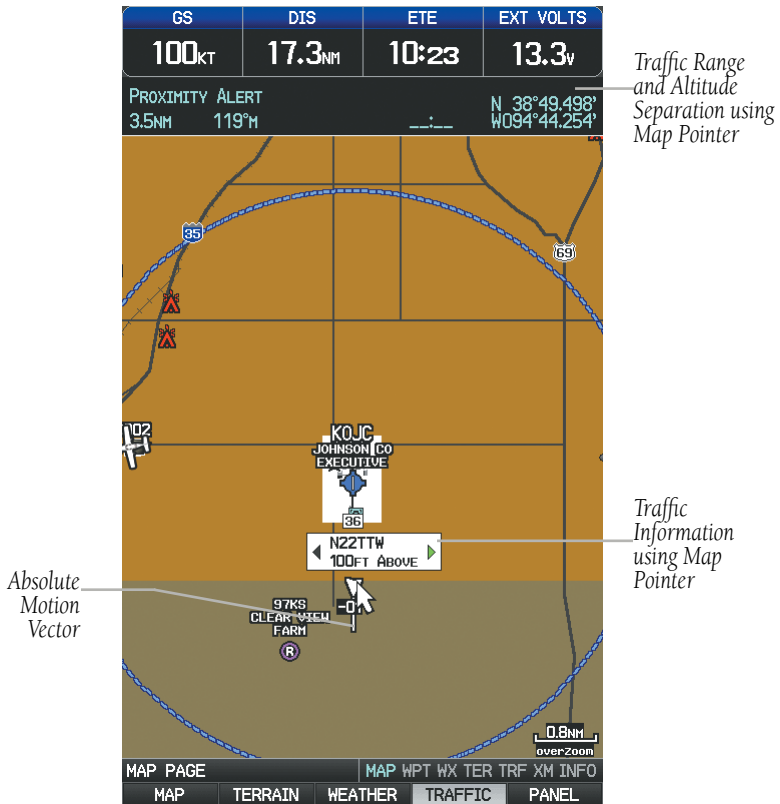

Traffic (Map Page)

DEDICATED TRAFFIC PAGE (TRF)



NOTE: Traffic alerts and altitude filters can only be changed on the dedicated Traffic Page (TRF). If the Traffic Page (TRF) is configured off audio alerts are enabled and the altitude filter is automatically set to 'Normal'

Displaying/Removing the Traffic Page:

- 1) Press the **MENU** Key twice to display the Main Menu.
- 2) Turn or move the **FMS** Joystick to highlight 'System Setup...' and press the **ENT** Key.
- 3) Turn or move the **FMS** Joystick to highlight 'Display', and press the **ENT** Key.
- 4) Move the **FMS** Joystick to highlight the Traffic Page field.
- 5) Turn the **FMS** Joystick to highlight 'Show' or 'Hide'.
- 6) Press the **FMS** Joystick, the **CLR** Key, the **EXIT** Softkey or the **MENU** Key to return to the previous page.

Changing the altitude range:

- 1) On the Traffic Page, select the **ALT MODE** Softkey.
- 2) Press one of the following Softkeys:
 - **ABOVE:** Displays non-threat and proximity traffic from 9000 feet above the aircraft to 2700 feet below the aircraft. Typically used during climb phase of flight.
 - **NORMAL:** Displays non-threat and proximity traffic from 2700 feet above the aircraft to 2700 feet below the aircraft. Typically used during enroute phase of flight.
 - **BELOW:** Displays non-threat and proximity traffic from 2700 feet above the aircraft to 9000 feet below the aircraft. Typically used during descent phase of flight.
 - **UNREST** (unrestricted): All traffic is displayed.
- 3) To return to the Traffic Page, press the **BACK** Softkey.

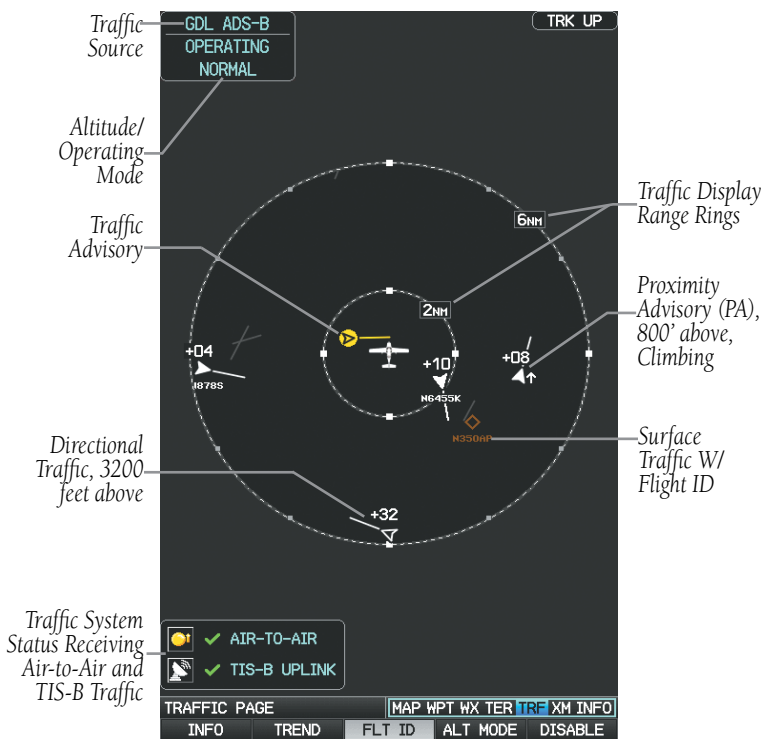

Traffic Page (GDL 39)

FLIGHT ID DISPLAY

The Flight IDs of other aircraft (when available) can be displayed on the Traffic Page. When a Flight ID or call sign is received, it will appear below the corresponding traffic symbol when enabled.



Example ADS-B Traffic Symbol

Enabling/Disabling Flight ID Display:

On the Traffic Page, press the **FLT ID** Softkey.

MOTION VECTORS

There are two pilot-selectable and mutually exclusive types of motion vectors, Absolute and TargetTrend, which are differentiated by color and function. Absolute vectors are white and indicate ground track as reported by the traffic. TargetTrend vectors are green and indicate the flight path and position, relative to your aircraft, at which the traffic will be after the passing of one of four predetermined look-ahead intervals. The end of the TargetTrend vector indicates the traffic's predicted location relative to your predicted location at the end of the look-ahead time. For example, if traffic is ahead of you and traveling along the same track but at a slower rate, the motion vector would point opposite of its indicated direction of flight showing that you are overtaking the traffic.

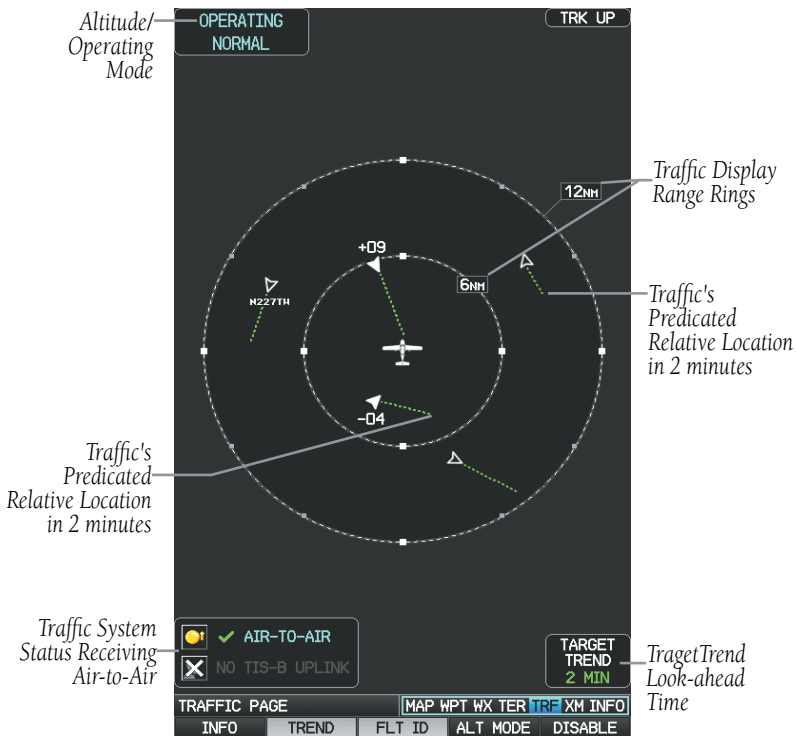

Traffic Page TargetTrend (GDL 39)

The TargetTrend look-ahead time interval is automatically adjusted from 30 seconds to five minutes and corresponds to the traffic display range setting. The greater the range setting, the longer the time interval and vice versa. Refer to the table below for more details.

Traffic Page Range Ring Settings	TargetTrend Look-ahead
.5nm to 2nm	30 seconds
2nm to 6nm	60 seconds
6nm to 12nm	2 minutes
12nm to 40nm	5 minutes

TargetTrend Look-ahead

Motion vector selection is made from the Traffic Page Menu by enabling/disabling TargetTrend. Absolute vectors are selected by default and are replaced when TargetTrend is enabled.

Enabling/Disabling TargetTrend:

On the Traffic Page, press the **TREND** Softkey.

Blank Page

SECTION 5 ADDITIONAL FEATURES



NOTE: With the availability of electronic documents/charts (i.e., SafeTaxi, Checklists, FliteCharts®, or ChartView (optional)), it is still advisable to carry another source of charts on board the aircraft.

The following additional features are supported depending on the unit (Americas, Atlantic, or Pacific).

Feature	Unit			
	GPSMAP 696	GPSMAP 695 Americas	GPSMAP 695 Atlantic	GPSMAP 695 Pacific
Airport Directory Data	+	+	+	+
ChartView	+	+	+	+
FliteCharts®	+	+		
SafeTaxi®	+	+		
SiriusXM®	+			
Electronic Checklists	+	+	+	+

Additional Features

5.1 SAFETAXI

SafeTaxi is an enhanced feature that gives greater map detail when viewing airports at close range. When viewing at ranges close enough to show the airport detail, the map reveals taxiways with identifying letters/numbers, runway incursion “Hot Spot”, and airport landmarks including ramps, buildings, control towers, and other prominent features. Resolution is greater at lower map ranges. The SafeTaxi feature can be seen on the Map Page and the Waypoint Page

Designated Hot Spots are recognized at airports with many intersecting taxiways and runways, and/or complex ramp areas. Airport Hot Spots are outlined to caution pilots of areas on an airport surface where positional awareness confusion or runway incursions happen most often. Hot Spots are defined by a red shaded area.

During ground operations the aircraft's position is displayed in reference to taxiways, runways, and airport features. When panning over the airport, features such as runway holding lines and taxiways are shown at the cursor.



SafeTaxi Depiction on the Map Page

Enabling/disabling SafeTaxi:

- 1) With the Map Page displayed, press the **Menu** Key. The Map Page Menu is displayed.
- 2) Turn or move the **FMS** Joystick to highlight 'Set Up Map' and press the **ENT** Key.
- 3) Turn the **FMS** Joystick to highlight the 'Airport' Category from the horizontal list.
- 4) Move the **FMS** Joystick to highlight the 'Safe Taxi' Field.
- 5) Turn the **FMS** Joystick to access the menu options.
- 6) Turn or move the **FMS** Joystick to select 'On' or 'Off', and press the **ENT** Key.

SAFETAXI CYCLE NUMBER AND REVISION

SafeTaxi database is revised every 56 days. SafeTaxi is always available for use after the expiration date. When turning on the GPSMAP 695/696, the Power-up Page indicates whether the databases are current, out of date, or not available. The Power-up Page shows the SafeTaxi database is current when the SafeTaxi Expires date is shown in white. When the SafeTaxi cycle has expired, the SafeTaxi Expires date appears in yellow.

The SafeTaxi Region, Version, Cycle, Effective date, and Expiration date of the database cycle can also be found in the Main Menu, under 'Database Information'.

The SafeTaxi database is provided by Garmin. Refer to Appendix C for instructions on updating the SafeTaxi database.

5.2 CHARTVIEW (OPTIONAL)



WARNING: Do not use the approach information provided by the VFR navigation database residing within the GPSMAP 695/696 as a means of navigating any instrument approach. The GPSMAP 695/696 VFR navigation database is limited to present only the waypoints for the final approach leg of a published procedure. These waypoints and associated course line are made available for monitoring purposes only.

ChartView resembles the paper version of Jeppesen terminal procedure charts. The MFD depiction displays the aircraft position on the moving map in the plan view of the approach charts and on airport diagrams.

The ChartView database subscription is available from Jeppesen, Inc. Available data includes:

- Arrivals (STAR)
- Departure Procedures (DP)
- Approaches
- Airport Diagrams
- NOTAMs

The geo-referenced aircraft position is indicated by an aircraft symbol displayed on the chart when the current position is within the boundaries of the chart. Inset boxes are not considered within the chart boundaries. Therefore, when the aircraft symbol reaches a chart boundary line, or inset box, the aircraft symbol is removed from the display.

The figure below, shows examples of off-scale areas, indicated by the grey shading. Note, the grey shading is for illustrative purposes only and will not appear on the published chart or display. These off-scale areas appear on the chart to convey supplemental information. However, the depicted geographical position of this information, as it relates to the chart planview, is not the actual geographic position. Therefore, when the aircraft symbol appears within one of these areas, the aircraft position indicated is relative to the chart planview, not to the off-scale area.

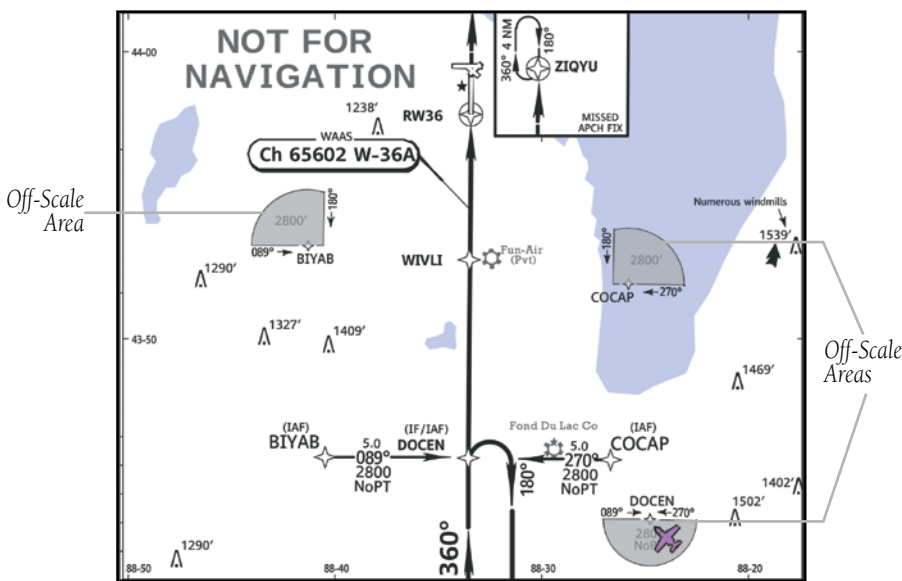

Sample Chart Indicating Off-Scale Areas

ChartView database is revised every 14 days. Charts are still viewable during a period that extends from the cycle expiration date to the disable date. ChartView is disabled 70 days after the expiration date and is no longer available for viewing. When turning on the system, the Power-up Page displays the current status of the ChartView database.

Displaying ChartView:

- 1) With the Waypoint (WPT) Page displayed, press the **CHART** Softkey.
- 2) Press the **FMS** Joystick to activate the cursor.
- 3) Move the **FMS** Joystick to highlight the Airport Identifier Field and use the **FMS** Joystick to begin entering the desired airport.

Or:

 - a) Move the **FMS** Joystick to highlight the Chart Field.
 - b) Turn the **FMS** Joystick to access a drop-down menu of available charts.
 - c) Turn or move the **FMS** Joystick to select the desired chart, and press the **ENT** Key.
- Or:**
- 1) From the Active Flight Plan Page (with a waypoint entered), press the **SEL APPR** Softkey. The Select Approach Window is displayed.
- 2) Press the **MENU** Key.
- 3) Turn or move the **FMS** Joystick to select 'Show Chart', and press the **ENT** Key. The selected chart is displayed.
- 4) Press the **EXIT** Softkey to return to the previous page.

Or:

 - 1) From the Map Page or Active Flight Plan Page, use the Map Pointer to highlight the desired airport and press the **ENT** Key. The Airport Information Window is displayed.
 - 2) Press the **CHART** Softkey.
 - 3) Press the **FMS** Joystick to activate the cursor.
 - 4) Turn the **FMS** Joystick to access a drop-down menu of available charts.
 - 5) Turn or move the **FMS** Joystick to select the desired chart, and press the **ENT** Key.

When a terminal procedure chart is not available for the requested airport or there is an error rendering the data, the banner “CHART NOT AVAILABLE” appears on the screen. The “CHART NOT AVAILABLE” banner does not refer to the ChartView subscription, but rather the availability of a particular airport chart selection or procedure for a selected airport.

CHART NOT AVAILABLE

Chart Not Available Banner

AIRCRAFT SYMBOL

The aircraft symbol is shown in magenta on the chart only if the chart is to scale and the aircraft position is within the boundaries of the chart. The aircraft symbol is not displayed when the Aircraft Symbol Not Shown Icon (X over the aircraft symbol) appears in the lower right corner. The Aircraft Symbol Not Shown Icon may appear at certain times, even if the chart is displayed to scale.

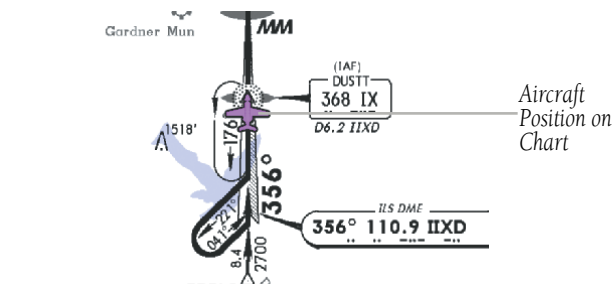

Aircraft Symbol Displayed on Chart (Waypoint Page)

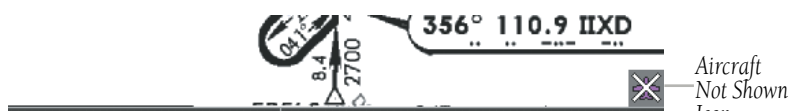

Aircraft Not Shown Icon (Waypoint Page)

Showing/Hiding the aircraft symbol on the chart:

Press the **CLR** Key to show/hide the aircraft symbol. The Aircraft Symbol Hidden Icon (circle with a line) is displayed in the lower right corner when the aircraft symbol is hidden.



Aircraft Hidden Icon (Waypoint Page)

CHART RANGE

Changing the chart range:

Use the down arrow on the **RNG** Key to zoom in (decreasing), or the up arrow to zoom out (increasing). Move the **FMS** Joystick to scroll the chart up, down, left, or right.

Or:

To quickly zoom all the way out, press the **CHART** Softkey. Press it again to return to the previous range (only available from the Waypoint Page).

JEPPESEN DATABASE-PUBLISHED NOTAMS



NOTE: Only NOTAM data for the selected airport is shown (when available). There may be other NOTAMs available pertaining to the flight that may not be displayed. Contact Jeppesen for more information regarding Jeppesen database-published NOTAMs.

Recent NOTAMs applicable to the current ChartView cycle are included in the ChartView database. If NOTAMs are available for the selected airport, a 'Chart NOTAMs' option will be displayed at the bottom of the drop-down menu of available charts. Select the 'Chart NOTAMs' option from the chart menu to display the applicable NOTAM information.

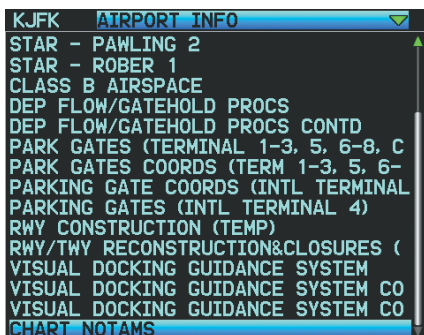

Drop-down Chart Menu

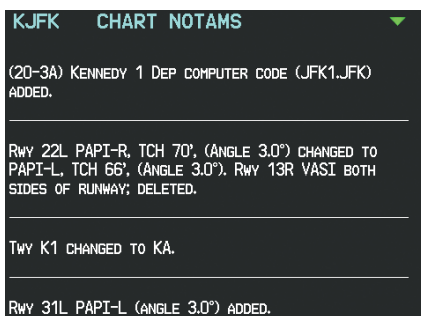

Chart Notams

5.3 FLITECHARTS[®]



WARNING: Do not use the approach information provided by the VFR navigation database residing within the GPSMAP 695/696 as a means of navigating any instrument approach. The GPSMAP 695/696 VFR navigation database is limited to present only the waypoints for the final approach leg of a published procedure. These waypoints and associated course line are made available for monitoring purposes only.

FliteCharts[®] resemble the paper version of National Aeronautical Charting Office (NACO) terminal procedures charts. The charts are displayed with high-resolution and in color for applicable charts. FliteCharts[®] database subscription is available from Garmin. Available data includes:

- Arrivals (STAR)
- Departure Procedures (DP)
- Approaches
- Airport Diagrams
- Takeoff Minimums
- Alternate Minimums

The geo-referenced aircraft position is indicated by an aircraft symbol displayed on the chart when the current position is within the boundaries of the chart. An aircraft symbol may be displayed within an off-scale area depicted on some charts.

The figure below shows examples of off-scale areas, indicated by the grey shading. Note, these areas are not shaded on the published chart. These off-scale areas appear on the chart to convey supplemental information. However, the depicted geographical position of this information, as it relates to the chart planview, is not the actual geographic position. Therefore, when the aircraft symbol appears within one of these areas, the aircraft position indicated is relative to the chart planview, not to the off-scale area.

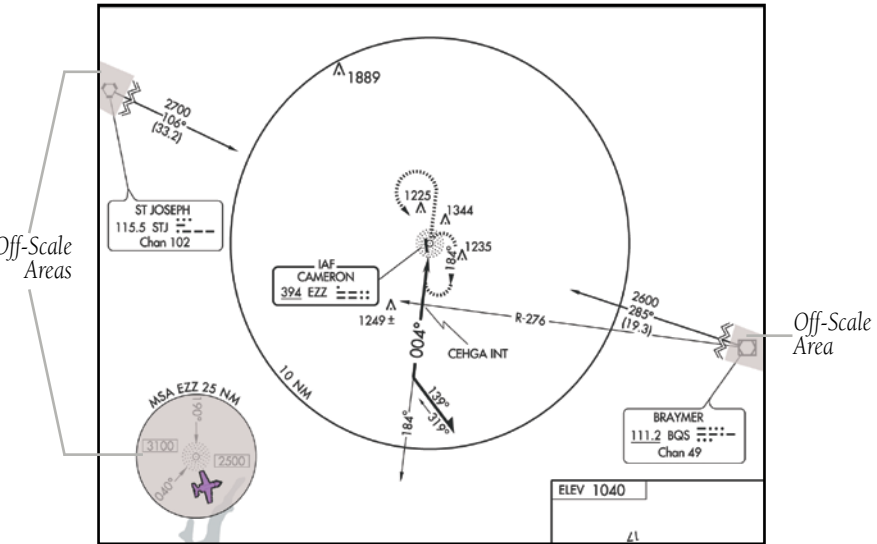
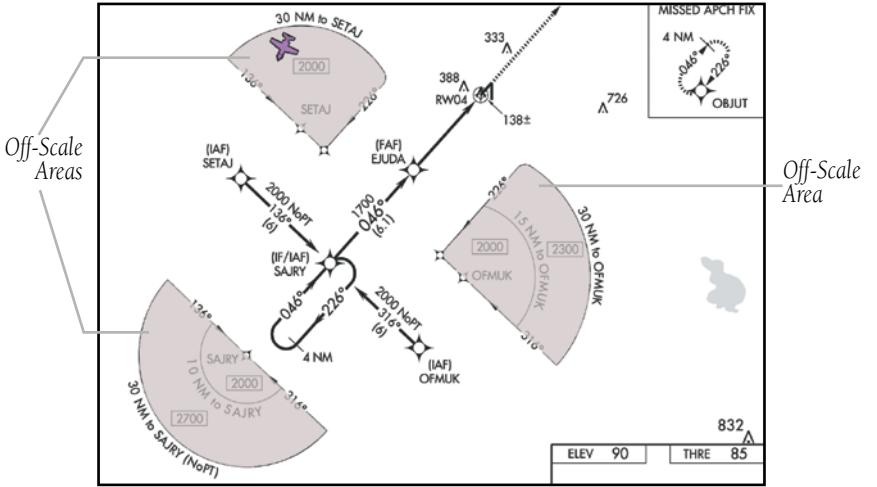

Sample Chart Indicating Off-Scale Areas



NOTE: Do not maneuver the aircraft based solely upon the geo-referenced aircraft symbol.

Displaying FliteCharts:

- 1) With the Waypoint (WPT) Page displayed, press the **CHART** Softkey.
 - 2) Press the **FMS** Joystick to activate the cursor.
 - 3) Move the **FMS** Joystick to highlight the Airport Identifier Field and use the **FMS** Joystick to enter the desired airport.
Or:
 - a) Move the **FMS** Joystick to highlight the Chart Field.
 - b) Turn the **FMS** Joystick to access a drop-down menu of available charts.
 - c) Turn or move the **FMS** Joystick to select the desired chart, and press the **ENT** Key.
-
- 1) From the Active Flight Plan Page or the Select Approach Window, press the **MENU** Key.
 - 2) Turn or move the **FMS** Joystick to select 'Show Chart', and press the **ENT** Key. The selected chart is displayed.
 - 3) Press the **EXIT** Softkey to return to the previous page.
Or:
 - 1) From the Map Page or Active Flight Plan Page, use the Map Pointer to highlight the desired airport and press the **ENT** Key. The Airport Information Window is displayed.
 - 2) Press the **CHART** Softkey.
 - 3) Press the **FMS** Joystick to activate the cursor.
 - 4) Turn the **FMS** Joystick to access a drop-down menu of available charts.
 - 5) Turn or move the **FMS** Joystick to select the desired chart, and press the **ENT** Key.

When a terminal procedure chart is not available for the requested airport or there is an error rendering the data, the banner "CHART NOT AVAILABLE" appears on the screen. The "CHART NOT AVAILABLE" banner does not refer to the FliteCharts® subscription, but rather the availability of a particular airport chart selection or procedure for a selected airport.



Chart Not Available Banner

CHART RANGE

Changing the chart range:

Use the down arrow on the **RNG** Key to zoom in (decreasing), or the up arrow to zoom out (increasing). Move the **FMS** Joystick to scroll the chart up, down, left, or right.

Or:

To quickly zoom all the way out, press the **CHART** Softkey. Press it again to return to the previous range.



FliteCharts® (Waypoint (WPT) Page)

AIRCRAFT SYMBOL

The aircraft symbol is shown in magenta on the chart only if the chart is to scale and the aircraft position is within the boundaries of the chart. The aircraft symbol is not displayed when the Aircraft Not Shown Icon appears. The Aircraft Not Shown Icon may appear at certain times, even if the chart is displayed to scale.

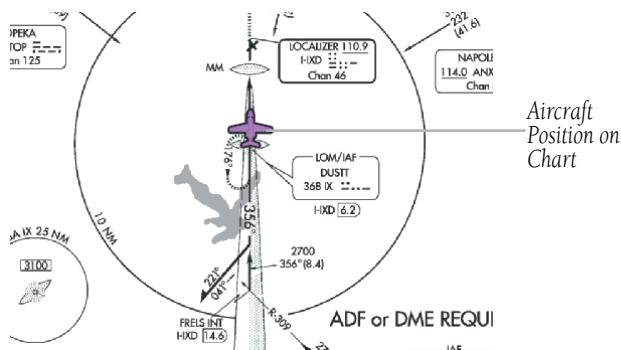

Aircraft Symbol Displayed on Chart (Waypoint Page)

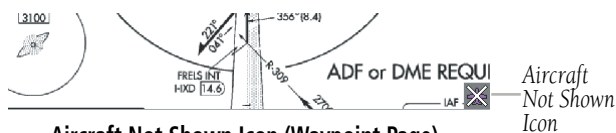

Aircraft Not Shown Icon (Waypoint Page)

5.4 AIRPORT DIRECTORY DATA

The Airport Directory contains airport statistics such as pattern altitudes, noise abatement information, FBO phone numbers, hours of operation, local attractions, ground transportation, lodging, and services.

The AOPA Airport Directory provides data on airports and heliports throughout the U.S. and it is updated on a 56-day cycle. Detailed information for over 5,300 U.S. airports, along with the names and phone numbers of thousands of FBOs can be viewed. This service allows the pilot to plan an overnight, choose fuel stops, find ground transportation, etc.

Optional airport directory databases such as AC-U-KWIK are also supported. AC-U-KWIK provides complete listings of FBOs, charter companies, fuel suppliers, ground transportation, maintenance and catering services at public airports across the world.



If the AOPA database is in use, the **AOPA** Softkey is displayed on the Waypoint (WPT) Page. If another airport directory database is in use, such as AC-U-KWIK, the **DIRECTORY** Softkey is displayed on the Waypoint (WPT) Page.

Viewing Airport Directory information:

From the Waypoint (WPT) Page, press the **AOPA** or **DIRECTORY** Softkey.

Or:

- 1) From any map highlight an airport using the Map Pointer, and press the **ENT** Key. The Airport Information Window is displayed.
- 2) Press the **AOPA** or **DIRECTORY** Softkey.
- 3) To return to the map, press the **ENT** Key, the **CLR** Key, or the **FMS** Joystick.

Icon	Description
	Restaurant on Field
	Self Serve Fuel
	Courtesy Car

Airport Directory Service Icons

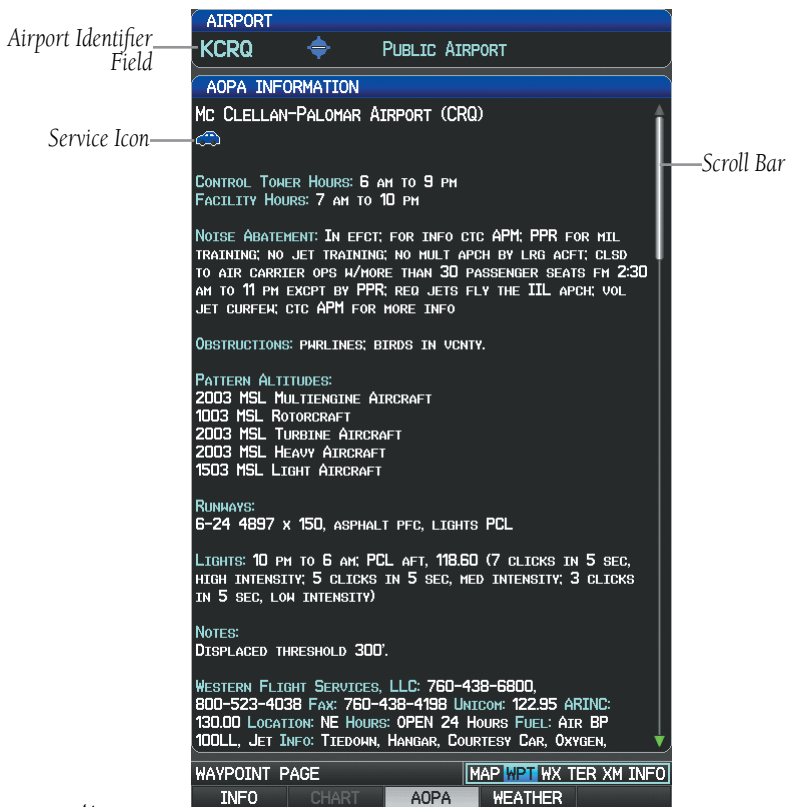

Airport
Directory
Softkey

Airport Directory Information (Waypoint (WPT) Page)

5.5 SIRIUSXM RADIO ENTERTAINMENT (GPSMAP 696)

Overview



NOTE: SiriusXM Satellite Radio is only available with the GPSMAP 696.

GPS Navigation



NOTE: Refer to the Hazard Avoidance Section for information about SiriusXM Weather products.

Flight Planning



NOTE: You **MUST** have a GXM 40 smart antenna connected to your GPSMAP 696 and a subscription to SiriusXM Radio to use SiriusXM Radio features. Additionally, you must use a third-party audio panel, headphones, or other audio device.

Hazard Avoidance



NOTE: Audio interference can occur while using some audio panels. Use of a Ground Loop Isolator can eliminate this interference.

Additional Features

SiriusXM Satellite Radio offers a variety of radio programming over long distances without having to constantly search for new stations. Based on signals from satellites, coverage far exceeds land-based transmissions. SiriusXM Satellite Radio services are subscription-based.

ACTIVATING SIRIUSXM SATELLITE RADIO SERVICES

Appendices

The service is activated by providing SiriusXM Satellite Radio with a coded ID (Radio ID).

SiriusXM Satellite Radio uses the Radio ID to send an activation signal that, when received by the GXM 40, allows it to play entertainment programming.

Refer to the GXM 40 Owner's Manual for more information on activating SiriusXM Satellite Radio.

Index

Accessing the Radio ID:

From the XM Audio Page press the **INFO** Softkey.

Or:

From the XM Audio Page select Channel '0' in the 'All Channels' Category.

Or:

- 1) From the WX Page press the **MENU** Key to display the WX Page Menu.
- 2) Turn or move the **FMS** Joystick to highlight 'Weather Products' and press the **ENT** Key.

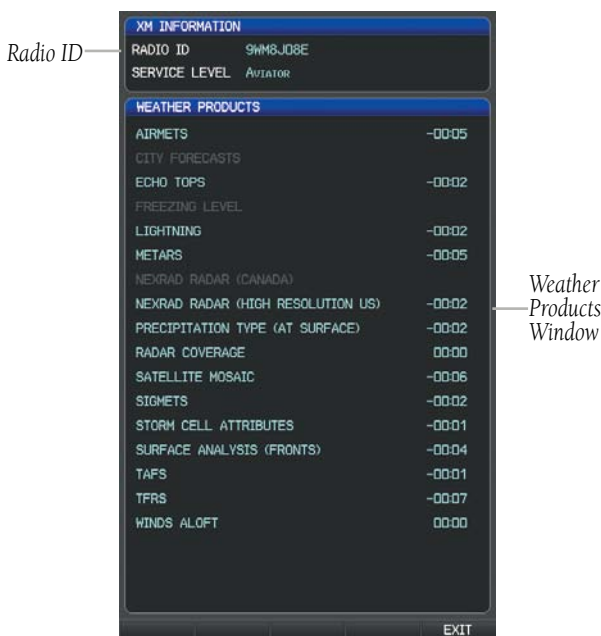

XM Information Page

USING SIRIUSXM RADIO

The XM Audio Page provides information and control of the audio entertainment features of the SiriusXM Satellite Radio.

Selecting the XM Audio Page:

- 1) Press the **FMS** Joystick to interact with the page navigation bar.
- 2) Turn the **FMS** Joystick to select the XM Audio Page.

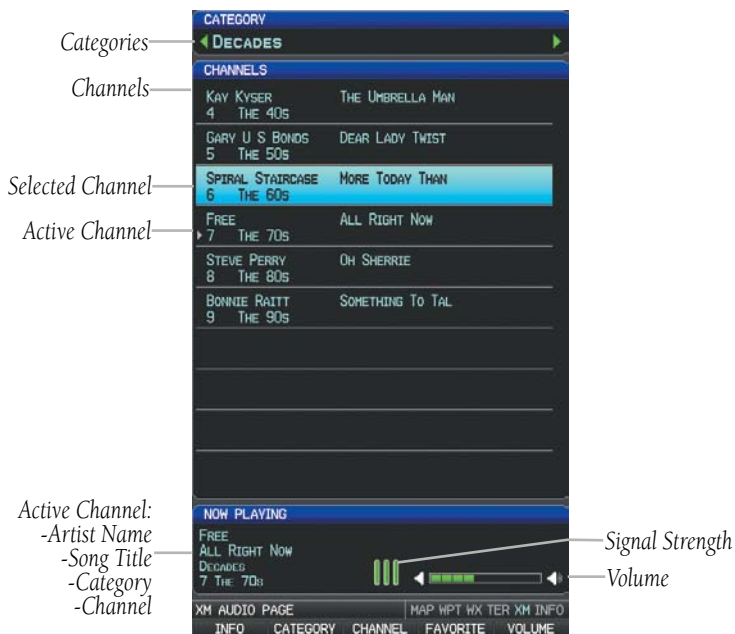

XM Audio Page

CATEGORY

The Category Field of the XM Audio Page cycles through a horizontal list of categories such as jazz, rock, or news.

Selecting a category:

- 1) Select the **CATEGORY** Softkey on the XM Audio Page. The Category Field is highlighted.



Category Field

- 2) Turn the **FMS** Joystick to highlight the desired category.
Or:

- 1) Press the **FMS** Joystick to activate the cursor. Move the **FMS** Joystick to highlight the Category Field (if necessary).
- 2) Turn the **FMS** Joystick to highlight the desired category.

Press and hold the **CATEGORY** Softkey to view the 'All Channels' Category.

ACTIVE CHANNEL AND CHANNEL LIST

The Channels List of the XM Audio Page shows a list of the available channels for the selected category. The currently selected channel will flash blue. The Active Channel is denoted by an arrow.



Active Channel

The Now Playing Box displays the currently selected channel, signal strength, and volume.



Now Playing Box

Selecting a channel:

- 1) From the XM Audio Page, press the **CHANNEL** Softkey. The Channel Field is highlighted.
- 2) Turn the **FMS** Joystick to highlight the desired channel and press the **ENT** Key.

Or:

- 1) Press the **FMS** Joystick. Move the **FMS** Joystick to highlight the Channel Field (if necessary).
- 2) Turn the **FMS** Joystick to highlight the desired channel and press the **ENT** Key.

Or:

- 1) From the XM Audio Page, press the **MENU** Key.
- 2) Turn or move the **FMS** Joystick to highlight 'Enter Channel' and press the **ENT** Key.
- 3) Turn the **FMS** Joystick to enter the desired channel and press the **ENT** or **CLR** Key.

USING FAVORITES

Favorites is a customized category of up to 30 of your SiriusXM Radio favorites.

To add a channel to Favorites:

- 1) With the favorites channel selected, press the **MENU** Key.
- 2) With 'Add To Favorites' selected, press the **ENT** Key.
- 3) With 'Yes' selected, press the **ENT** Key.



Adding a Channel to Favorites

Selecting Favorites:

- 1) Select the **FAVORITE** Softkey on the XM Audio Page. The Favorites category is displayed.
- 2) Press the **FMS** Joystick to activate the cursor.
- 3) Move the **FMS** Joystick to select the desired channel and press the **ENT** Key.
Or:
- 1) Press the **FMS** Joystick to activate the cursor. Move the **FMS** Joystick to highlight the Category Field (if necessary).
- 2) Turn the **FMS** Joystick to highlight the Favorites category.
- 3) Move the **FMS** Joystick to select the desired channel and press the **ENT** Key.

To delete a channel from Favorites:

- 1) With the Favorites channel selected, press the **MENU** Key.
- 2) With 'Delete Favorite' selected, press the **ENT** Key.

Or:

Highlight 'Delete All Favorites' and press the **ENT** Key to delete all channels from the Favorites list.

VOLUME

Radio volume is shown in the Now Playing Box.

Adjusting the volume:

- 1) With the XM Audio Page displayed, select the **VOLUME** Softkey.
- 2) Select the **VOL -** Softkey to reduce volume or select the **VOL +** Softkey to increase volume.

Or:

Turn the **FMS** Joystick 'right' to increase the volume or 'left' to decrease the volume.

Muting SiriusXM Audio:

- 1) With the XM Audio Page displayed, select the **VOLUME** Softkey.
- 2) Select the **MUTE** Softkey to mute the audio. Select the **MUTE** Softkey again to unmute the audio.

Or:

Press and hold the **VOLUME** Softkey to mute and unmute the audio.

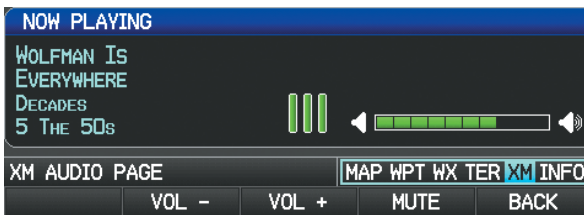

Volume Control

SHOW/HIDE THE XM AUDIO PAGE

The XM Audio and WX Pages can be hidden from view.

Showing/Hiding the XM Audio Page:

- 1) Press the **MENU** Key twice to access the Main Menu.
- 2) Select 'System Setup' and press the **ENT** Key.
- 3) Select 'Display' and press the **ENT** Key.
- 4) Move the **FMS** Joystick to the 'XM Audio & WX Pages' field.
- 5) Turn the **FMS** Joystick to select 'Hide' or 'Show' and press the **ENT** Key, the **CLR** Key, or the **FMS** Joystick.

5.6 ELECTRONIC CHECKLISTS



NOTE: The information described in this section is not intended to replace the checklist information described in the AFM.



NOTE: Garmin does not create, modify, or update GPSMAP 695/696 checklists and thus cannot be responsible for the availability and/or content.



NOTE: Checklists cannot be edited from within the unit.

The GPSMAP 695/696 is capable of displaying checklists (if available from the aircraft manufacturer) which allow a pilot to quickly find the proper procedure on the ground and during each phase of flight. The GPSMAP 695/696 accesses the checklist file (*.ace) from the root directory (/*.ace) of the SD card. If a checklist file is available on the SD card, the 'Checklists' Main Menu Option will appear.

5.7 FLIGHT DATA LOGGING

The flight data logging feature automatically stores flight data to an SD card. Data is recorded to the SD card every second. A data file is created each time the system is powered on with an SD card inserted, or each time an SD card is inserted after power on. A 2 GB SD card can store over 1,000 hours of flight data or up to 1,000 files (whichever comes first). The data files stored on the SD card have an extension of .csv. This file format can be opened using a spread sheet application on a personal computer.

SECTION 6 APPENDICES

MESSAGES, ALERTS & DATA FIELD OPTIONS

SYSTEM MESSAGES

Message	Comments
Antenna Shorted to Ground	The external GPS antenna has an electrical connection problem. Contact Garmin Product Support.
Approaching Target Altitude	Within 1,000 feet of final VNAV target altitude.
Approaching VNAV Profile	The aircraft is within one minute of reaching the initial VNAV decent point.
Arriving at XXX	The aircraft is nearing the destination.
Battery Low	The battery needs to be recharged.
Can't Unlock Maps	No applicable unlock code for one or more maps was found. All MapSource maps are not accessible.
Check XM Antenna	Internal problem with your GXM 40 antenna. Contact Garmin Product Support.
Database Error	Internal problem with the unit. Contact your dealer or Garmin Product Support to have the unit repaired.
Fuel Tank	A reminder for switching fuel tanks. The reminder message repeats at the specified interval after the beginning of each trip.
Lost Satellite Reception	The unit is unable to receive satellite signals.
Memory Full	Unit memory is full, no further data can be saved.
Near Proximity Point	You have reached the distance set for a proximity waypoint.

Message	Comments
Next DTK XXX	The aircraft is nearing a turn in a route.
No XM Signal	The GXM 40 antenna is not receiving a SiriusXM signal.
Proximity Memory Full	No additional proximity waypoints can be saved.
Proximity Radius Overlaps	The radii of two proximity waypoints overlap.
Route Already Exists	A route with the same name already exists.
Route Memory Full	No additional routes can be saved.
Route Truncated	Uploaded route from another device has more than 300 waypoints.
Route Waypoint Memory Full	No additional route waypoints can be saved.
Saving XM Program Information	A SiriusXM Radio channel lineup change has occurred and the unit is saving the channel lineup to memory.
Steep Turn	Approaching a turn that requires a bank angle in excess of 25 degrees to stay on course.
Track Already Exists	A saved track with the same name already exists.
Track Log Full	The track log is full and track recording was turned off. To record more track points, you need to clear the track log and turn track recording on.
Track Memory Full	No more track data can be stored. Delete the old track data to store the new data.
Track Truncated	A complete uploaded track will not fit in memory. The oldest track log points have been deleted.
Transfer Complete	Data Transfer was completed.
VNAV Cancelled	VNAV function has been cancelled due to a change in the active route.
Waypoint Already Exists	A waypoint with the same name already exists.

Message	Comments
Waypoint Memory Full	The unit has stored the maximum number of waypoints.
XM Antenna Not Responding	The unit is unable to communicate with the GXM 40.

AIRSPACE MESSAGES

Message	Comments
Inside Airspace	Inside the boundaries of the airspace.
Airspace Near and Ahead	Within two nautical miles of an airspace and your current course takes you inside the airspace.
Airspace Ahead, Within 10 Minutes	The projected course takes you inside an airspace within the next 10 minutes or less.
Airspace Near, Within 2 nm	Within two nautical miles of an airspace but not projected to enter it.

AURAL ALERTS

TRAFFIC

- “Traffic”—TIS-A traffic alert received.
- “Traffic Not Available”—TIS-A service is not available or out of range.

TERRAIN

- “Five Hundred”—when the aircraft descends through 500 feet above the destination airport.

The following aural terrain alerts are issued when flight conditions meet parameters that are set within the software algorithms, and are dependant on the sensitivity level set in the Terrain Setup Menu.

Alert Severity	Terrain	Obstacle	Descent Rate
Caution	"caution, terrain" "caution, terrain ahead"	"caution, obstacle" "caution, obstacle ahead"	"caution, sink rate"
Warning	"terrain ahead! pull up!" "terrain! terrain! pull up! pull up!"	"obstacle ahead! pull up!" "obstacle! obstacle! pull up! pull up!"	"sink rate, pull up!" "pull up!"

Aural Alerts

DATA FIELD OPTIONS

Data Field Option	Definition
Accuracy	The current accuracy of the GPS determined location.
Altitude	The current altitude in geometric height above Mean Sea Level (MSL).
Battery	The current battery level.
Bearing (BRG)	The compass direction from the present position to a destination waypoint.
Course to Steer (CTS)	The recommended direction to steer in order to reduce cross-track error and return to the course line.
Crosstrack Error (XTK)	The distance the aircraft is off a desired course in either direction, left or right.
Desired Track (DTK)	The desired course between the active "from" and "to" waypoints.
Distance (Destination) (DIST DEST)	The distance to the destination waypoint in the Active Flight Plan.
Distance (Next) (DIST NEXT)	The distance to the next waypoint in the Active Flight Plan.

Data Field Option	Definition
En Route Safe Altitude (ESA)	The recommended minimum altitude within ten miles left or right of the desired course on a active flight plan or direct-to.
Estimated Time En Route (Destination) (ETE DEST)	The estimated time it takes to reach the destination waypoint from the present position, based upon current ground speed.
Estimated Time En Route (Next) (ETE NEXT)	The estimated time it takes to reach the next waypoint form the present position, based upon current ground speed.
Estimated Time of Arrival (Destination) (ETA DEST)	The estimated time at which the aircraft should reach the destination waypoint, based upon current speed and track.
Estimated Time of Arrival (Next) (ETA NEXT)	The estimated time at which the aircraft should reach the next waypoint, based upon current speed and track.
Estimated Time to VNAV (VNAV TIME)	The estimated time it takes to reach the VNAV waypoint form the present position, based upon current ground speed.
External Voltage (EXT VOLTS)	Voltage on the external power input (cigarette lighter receptacle).
Flight Timer (FLT TIMER)	Total time in-flight (HH:MM).
Fuel Tank Timer (FUEL TIMER)	Elapsed time since the Fuel Tank Reminder Alarm was last issued (HH:MM).
Glide Ratio (G/R)	The estimated distance an aircraft will move forward for any given amount of lost altitude.
Ground Speed (GS)	The velocity that the aircraft is traveling relative to a ground position.
Ground Track (TRK)	The direction of aircraft movement relative to a ground position.
Minimum Safe Altitude (MSA)	Uses Grid MORAs to determine a safe altitude within ten miles of the aircraft's present position.

Data Field Option	Definition
Next Waypoint (NEXT WPT)	The next waypoint in the flight plan or direct-to route.
Sunrise	The time at which the sun rises on this day (current location).
Sunset	The time at which the sun sets on this day (current location).
Time (UTC)	The current time and date in Universal (UTC) time.
Time of Day (TIME)	The current time and date in 12-hour or 24-hour format.
Vertical Speed (VS)	The rate of climb or descent (GPS-derived).
Vertical Speed Required (VSR)	The vertical speed necessary to descend/climb from the current position and altitude to the previously selected VNAV position and altitude, based upon current ground speed.
Weather (Altimeter) (WX ALTIM)	The altimeter setting at the nearest METAR reporting station.
Weather (Dew Point) (WX DEW PT)	The dew point at the nearest weather reporting station.
Weather (Rel. Humidity) (WX HUMIDITY)	The relative humidity at the nearest weather reporting station.
Weather (Temperature) (WX TEMP)	The temperature at the nearest weather reporting station.
Weather (Wind) (WX WIND)	The wind speed and direction at the nearest weather reporting station.

ABNORMAL OPERATION

RESETTING THE UNIT

To reset the unit:

Remove the power source and restart the unit.

Or:

Hold down the #1 Softkey, #5 Softkey, and zoom out using the **RNG** Key.

LOSS OF GPS POSITION

When the GPSMAP 695/696 loses the GPS signal for any reason, the following will occur:

- A blinking red question mark will appear over the airplane icon on the map.
- The 'Lost Satellite Reception' message will display.
- Any GPS dependent data fields will not be available.

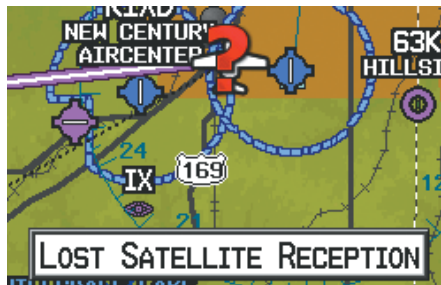

GPS Signal Lost

HAZARD DISPLAY WITH LOSS OF GPS POSITION

If the Terrain Page doesn't have at least a 3D fix (i.e. altitude unknown), a Red X will be displayed.



Terrain Page Red X

SD CARD USE AND DATABASES

SD CARD USE

The GPSMAP 695/696 uses an optional SD Card for storing MapSource® data and user-downloaded vehicles.

MAPSOURCE DETAILED MAPS

The included USB Interface Cable is used to transfer MapSource® CD-ROM data to the optional SD Card.

For compatible MapSource® products, refer to the Garmin web site at www.garmin.com/cartography.

INSTALLING AND REMOVING SD CARDS

Install the SD Card in the slot located on the top, left side of the unit. Install or remove the SD Card at any time, whether the unit is on or off.

You can load a variety of information on your SD Card, such as MapSource detailed maps in a MapSource program. You can buy pre-programmed SD Cards to use with your GPSMAP 695/696.

SD Cards are not waterproof. They should not be exposed to moisture or excessive static charges, and should be stored in the case supplied with the card.



GPSMAP 695/696 SD Card Slot

Installing an SD Card:

- 1) Insert the card into the slot on the top, left side of the unit. Be sure the label is facing the front of the unit.
- 2) Firmly push the card into the unit. It is not necessary to force the card. The handle is still exposed when it is properly inserted.
- 3) The unit takes a few seconds to read the card. When the data card has been properly installed and accepted, a summary screen noting the card details appears. Press **ENT** Key to acknowledge.

If you insert an SD Card and get a card format not recognized message, try removing the card and reinserting it. If the card is still not recognized, contact Garmin Product Support or your Garmin dealer.

Removing an SD Card:

- 1) Push the card into the unit until it stops.
- 2) Release the card. The card should eject for easy removal.
- 3) With the card ejected, pull the card out of the slot.

GPSMAP 695/696 DATABASES

The following databases are included with the GPSMAP[®] 695/696 depending on the unit (Americas, Atlantic, or Pacific). See the Additional Feature section for information on AOPA Airport Directory, AC-U-KWIK Airport Directory, FliteCharts[®], Chartview, and SafeTaxi[®]. See the Hazard Avoidance section for information on Obstacles and Terrain.

Database	Americas Unit	Atlantic Unit	Pacific Unit
Worldwide Basemap	+	+	+
AOPA Airport Directory	+		
Jeppesen® Navigation Database	+	+	+
FliteCharts®	+		
SafeTaxi®	+		
Obstacle	+	+	
Terrain	+	+	+

Databases

BASEMAP

The basemap database contains data for the topography and land features, such as river, lakes, and towns. It is updated only periodically, with no set schedule. There is no expiration date.

AIRPORT DIRECTORY DATABASES

The AOPA Airport Directory provides data on airports and heliports throughout the U.S. and it is updated on a 56-day cycle. Detailed information for over 5,300 U.S. airports, along with the names and phone numbers of thousands of FBOs can be viewed. This service allows the pilot to plan an overnight, choose fuel stops, find ground transportation, etc.

Optional airport directory databases such as AC-U-KWIK are also supported. AC-U-KWIK provides complete listings of FBOs, charter companies, fuel suppliers, ground transportation, maintenance and catering services at public airports across the world.

NAVIGATION DATABASE

The GPSMAP 695/696 includes an internal navigation database that provides location and facility information for thousands of airports, VORs, NDBs, and more. Updates to the navigation database are available every 28 days online (www.fly.garmin.com). There are two navigation database products available: the Jeppesen Navigation Database, which is sourced by Jeppesen, and the US VFR Navigation Database sourced by AeroNav Products, a division of the FAA. The update program is designed to operate on Windows®-compatible PCs and requires the included USB cable to connect your GPSMAP 695/696 to the PC's USB port. The following information is provided from the internal navigation database:



NOTE: *Although the Jeppesen Navigation Database and the US VFR Navigation Database contain much of the same information, pilots may notice differences in behavior, nearest list functionality, direct-to functionality, and map page display due to data content variations. The US VFR Navigation Database, by AeroNav Products, does not contain any approach data.*

- *Airport—identifier, facility name, city/state/country, latitude/longitude, field elevation, available fuel types, runway designations and layout, runway surface, runway length, runway width, runway lighting, communication frequencies, and published approaches (Jeppesen Navigation Database only).
- Weather—frequencies associated with an airport (ASOS, ATIS, and AWOS).
- *VORs—identifier, facility name, city/state/country, location (latitude/longitude), frequency, service volume (high, low, terminal), and type (such as VOR-DME, TACAN, and VORTAC).
- *NDBs—identifier, facility name, city/state/country, location (latitude/longitude), and frequency.
- Intersections—identifier, nearest VOR, radial and distance from nearest VOR, location (latitude/longitude), and region/country.
- ARTCC—Air Route Traffic Control Centers.
- Airspace—boundaries (Class B, Class C, Control Zones, SUAs, and MOAs), controlling agency, and vertical boundaries.

- FSS—Flight Service Stations.

* Symbology used for NDBs, VORs, and airports is consistent with those used on a sectional chart.



NOTE: After performing a navigation database update, verify all flight plan(s) (routes) are current. If there is an obsolete aviation point in a saved route, the route is locked and unusable. A new route with current navigation database points will need to be created.

FLITECHARTS®

The FliteCharts® database contains procedure charts for the United States only. This database is updated on a 28-day cycle.

CHARTVIEW (OPTIONAL)

ChartView database is revised every 14 days. Charts are still viewable during a period that extends from the cycle expiration date to the disable date. ChartView is disabled 70 days after the expiration date and is no longer available for viewing. The ChartView database is always on the SD Card and is not copied to the unit's internal memory.

SAFETAXI

The SafeTaxi database contains detailed airport diagrams for selected airports. These diagrams aid in following ground control instructions by accurately displaying the aircraft position on the map in relation to taxiways, ramps, runways, terminals, and services. This database is updated on a 56-day cycle.

OBSTACLE

The obstacle database contains data for obstacles, such as towers, that pose a potential hazard to aircraft. Obstacles 200 feet and higher are included in the obstacle database. It is very important to note that not all obstacles are necessarily charted and therefore may not be contained in the obstacle database. This database is updated on a 56-day cycle.

TERRAIN



NOTE: The data contained in the terrain and obstacle databases comes from government agencies. Garmin accurately processes and cross-validates the data, but cannot guarantee the accuracy and completeness of the data.

The terrain database is updated periodically and has no expiration date.

UPDATING GPSMAP 695/696 DATABASES

The GPSMAP 695/696 database updates can be obtained by visiting the 'flyGarmin' website (www.fly.garmin.com). The 'flyGarmin' website requires the unit's ID to update databases. This allows the databases to be encrypted with the unit's unique ID when copied to the SD Card.

Obtaining the Unit ID:

- 1) Press the **MENU** Key twice to access the Main Menu.
- 2) Select 'System Setup' and press the **ENT** Key.

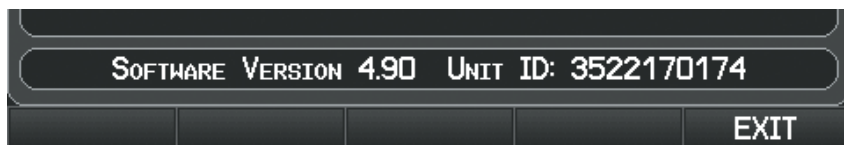

System Setup Page

Or:

Select 'Database Information' and press the **ENT** Key.

Unit ID

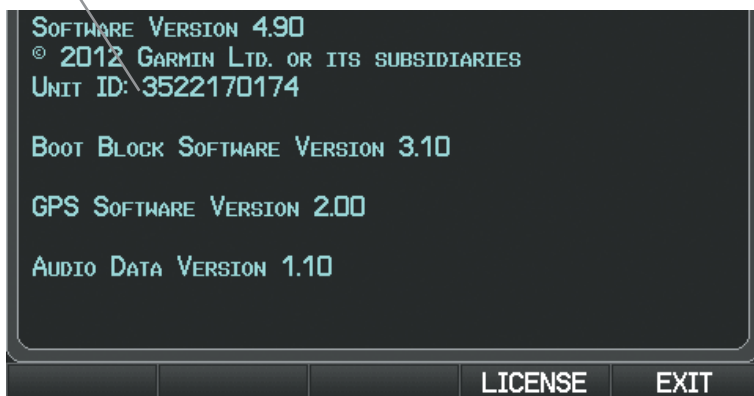

Database Information Page

Updating GPSMAP 695/696 Databases:

Equipment required to perform the update:

- Windows-compatible PC computer (Windows 2000 or XP recommended)
 - Verbatim 96504 SD Card Reader or equivalent
 - Updated database obtained from the flyGarmin website
 - SD Card, 2 GB recommended (Garmin recommends Verbatim 96504)
- 1) After the data has been copied to the SD Card, insert the SD card in the SD card slot of the unit.
 - 2) Power on the unit. The Update Databases Page is displayed. A green checkbox indicates that the database currently installed on the GPSMAP 695/696 is up to date. An empty checkbox indicates that the database on the SD card is more current and should be installed.

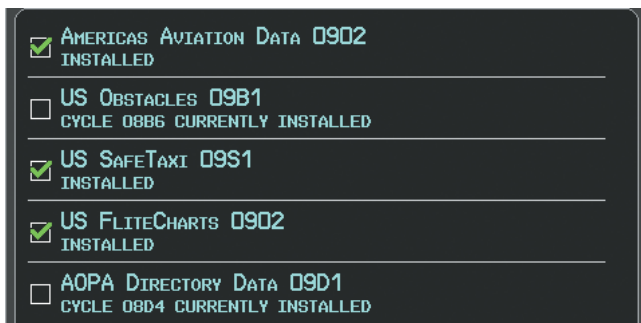

Update Databases Page

- 3) With 'Update All' highlighted, press the **ENT** Key. The database status is updated.



Update Databases Page

Or:

Move the **FMS** Joystick to highlight a single database to update, and press the **ENT** Key. The database status is updated.

Update Databases Page
(Database Status Updated)

- 4) Press the **RESTART** Softkey. Once the database(s) have been successfully updated, the SD Card can be removed from the unit.



Update Databases Page

EXPORTING TRACK LOGS AND USER WAYPOINTS

Exporting a track log:

- 1) Press the **MENU** Key twice.
- 2) Turn or move the **FMS** Joystick to select 'Track Log' from the Main Menu, and press the **ENT** Key.
- 3) Using the **FMS** Joystick highlight the desired track log to export.
- 4) With an SD card inserted, press the **EXPORT** Softkey.

Exporting User Waypoints:

- 1) Press the **MENU** Key twice.
- 2) Turn or move the **FMS** Joystick to select 'User Waypoints' from the Main Menu, and press the **ENT** Key.
- 3) With an SD card inserted, press the **Menu** Key.
- 4) Turn or move the **FMS** Joystick to select 'Export Waypoints' from the Option Menu, and press the **ENT** Key.

IMPORTING/EXPORTING FLIGHT PLANS

Importing flight plans:

- 1) With a flight plan saved to the SD Card, press the **FPL** Key and turn the **FMS** Joystick to display the Flight Plan List Page.
- 2) Press the **IMPORT** Softkey.
- 3) Using the **FMS** Joystick highlight the desired flight plan to import.
- 4) Press the **IMPORT** Softkey and press the **ENT** Key.
Or: Press **Menu** and with 'Import Flight Plan' highlighted press **ENT**.

Exporting flight plans:

- 1) Press the **FPL** Key and turn the **FMS** Joystick to display the Flight Plan List Page.
- 2) Press the **FMS** Joystick to activate the cursor, and turn or move the **FMS** Joystick to highlight the desired flight plan.
- 3) Press the **EXPORT** Softkey and press the **ENT** Key.
Or: Press **Menu** and with 'Export Flight Plan' highlighted press **ENT**.

INSTALLATION & INTERFACING INFORMATION

Overview

GPS Navigation

Flight Planning

Hazard Avoidance

Additional Features

Appendices

Index

CONNECTING THE POWER/DATA CABLE

The power/data cable connects the GPSMAP 695/696 to an 9-40 VDC system and provides interface capabilities for connecting external devices. The color code in the diagram below and to the right indicates the appropriate harness connections. Replacement fuse is 4 Amp.

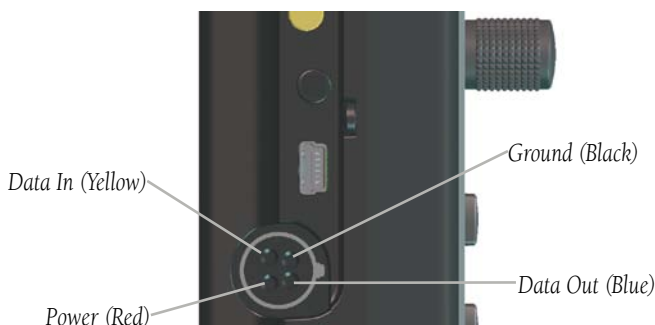

Power/Data Connector on the GPSMAP 695/696 Unit

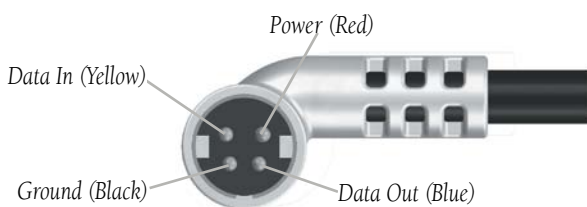

Power/Data Connector on the Cable



GPSMAP 695/696 and Power/Data Connector

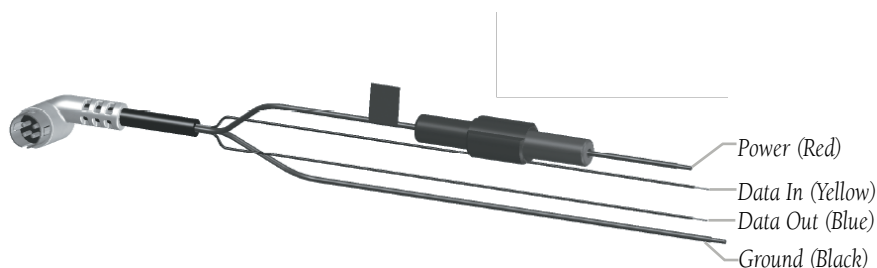

Bare Wire Power/Data Cable for the GPSMAP 695/696 Unit

CONNECTING TO A GARMIN VHF COMM RADIO

The GPSMAP 695/696 can also output frequency data to a Garmin aviation radio. Currently the two models supported are the SL30 nav/comm and the SL40 comm.



NOTE: For additional information refer to the SL30 nav/comm or the SL40 comm installation manual.



NOTE: This interface does not have an FAA installation airworthiness approval. If any abnormalities with SL 30/40 tuning or operation are encountered, disconnect the GPSMAP 695/696 from the SL 30/40 tuning interface.

Output frequency data to an SL40/SL30 nav/comm radio:

- 1) Connect the Data Out pin on the GPSMAP 695/696 to the RxD pin on the comm radio. (You do not need to connect the comm radio to the GPSMAP 695/696's Data In pin.)
- 2) Press the **MENU** Key twice to access the Main Menu.
- 3) Select 'System Setup...' and press the **ENT** Key.
- 4) Select 'Interface' and press the **ENT** Key.
- 5) With the Serial Data Format field highlighted, turn the FMS Joystick to select 'GTX TIS-A In/NMEA & VHF Out' or 'Aviation In/NMEA & VHF Out'. These comm modes send both NMEA data and VHF frequency information.

The following features are now available on the radio:

- Remote frequency lists for departure, enroute, and arrival airports.
- Nearest VOR frequencies (SL30 only).

The GPSMAP 695/696 can also directly tune a standby frequency.

Selecting a standby comm frequency:

- 1) Enter an airport identifier on the Waypoint Page.
- 2) Move the **FMS** Joystick to the 'Frequencies' Box.
- 3) With the desired frequency selected, press the **ENT** Key. The frequency is now tuned in standby.

CONNECTING TO A COMPUTER

Your GPSMAP 695/696 can be connected to your computer using the included USB-PC Interface Cable to connect to a USB data port.

Connecting to a computer:

- 1) Connect the small end of your cable to the connector on the left side of the GPSMAP 695/696.
- 2) When using the supplied USB Data Cable, connect the larger end of the cable to an available USB data port.

INFORMATION ABOUT USB DRIVERS

When connecting the GPSMAP 695/696 to a USB port, the computer prompts you to locate the destination of the drivers for the device (a USB drivers CD is included). Only install the drivers once. After the drivers are installed, your computer always detects your GPSMAP 695/696 when it is connected. USB driver updates can be found at www.garmin.com.

USING XIMAGE FOR CUSTOMIZED WAYPOINT SYMBOLS

xImage allows you to exchange images between your PC and your GPSMAP 695/696. You can download and save screen shots of any screen shown on your unit. xImage also allows you to download customized splash screens and waypoint symbols from compatible GPS units, customize them (if you have an image editing program on your PC), and send them back to your GPS unit.

You can download xImage from the Garmin Web site at www.garmin.com/ximage. Refer to the help file for complete instructions about using xImage.

CONNECTING THE GXM 40 ANTENNA (GPSMAP 696)

Connect the GXM 40 antenna to the GPSMAP 696 to access SiriusXM Satellite Weather and SiriusXM Radio. For more information about the GXM 40 antenna, see the GXM 40 Owner's Manual.



NOTE: You must subscribe to SiriusXM Radio and/or SiriusXM WX Satellite Weather to use the SiriusXM Radio and/or SiriusXM Weather features on your GPSMAP 696.

Connecting the GXM 40 antenna:

- 1) Position the antenna where it has a clear view of the sky. This can be on the outside of the vehicle or behind the windscreen.
- 2) Plug the GXM 40 cable into the USB port on the left side of the unit, as shown in the following illustrations.



GXM 40 Antenna

INTERFACING

The following formats are supported for connection of external devices: NMEA 0180, 0182, 0183 (versions 1.5, 2.0, 2.3, 3.01), ASCII Text Output, and Garmin proprietary formats for connecting to a Mode S transponder for TIS-A data, and to a Garmin aviation NAV/COM radio.

The following are the Approved Sentences for NMEA 0183, version 3.01 output: GPRMC, GPGGA, GPGSA, GPGSV, GPGLL, GPBOD, GPRTE, and GPWPL. The following are the Proprietary Sentences for NMEA 0183, version 3.01 output: PGRME, PGRMZ, PGRMM, and PGRMH.

The GPSMAP 695/696 also includes NMEA input with support for the BWC, DBT, DPT, MTW, VHW, VTG, and XTE sentences.

Garmin's proprietary communication protocol is available from the Web site (www.garmin.com).

GENERAL INTERFACE SETUP

The Interface Setup controls the input/output format used when connecting the unit to external devices.

Selecting an interface:

- 1) Press the **MENU** Key twice to select the Main Menu.
- 2) Turn or move the **FMS** Joystick to select 'System Setup', and press the **ENT** Key.

- 3) Turn or move the **FMS** Joystick to select 'Interface', and press the **ENT** Key.
- 4) With the Serial Data Format field highlighted, turn the **FMS** Joystick to select the desired Serial Data Format.

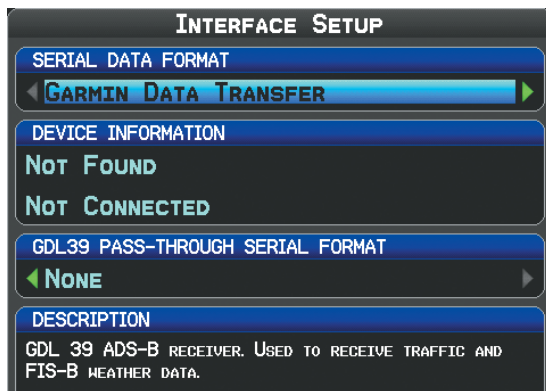

Interface Setup (Main Menu)

SERIAL DATA FORMATS

- Garmin Data Transfer—the proprietary format used to exchange data with a PC, Garmin GDL 39, or another Garmin GPSMAP 695/696.
- NMEA In/NMEA Out—transmits NMEA position, velocity, and navigation data.
- Aviation In—the proprietary format used for connection to a Garmin panel-mounted GPS receiver. This eliminates the need to enter the destination on both units.
- Aviation In/NMEA & VHF Out—receives aviation data and transmits out both NMEA data, at 9600 baud, and VHF frequency tuning information to a Garmin Nav/Comm radio.
- GTX TIS-A In—receives TIS-A data from a Garmin Mode S transponder or other compatible device.
- GTX TIS-A In/NMEA & VHF Out—receives TIS-A data and transmits out both NMEA data, at 9600 baud, and VHF frequency tuning information to a Garmin Nav/Comm radio.
- None—provides no interfacing capabilities.

ADVANCED NMEA OUTPUT SETUP

If interfacing the GPSMAP 695/696 with another piece of equipment (such as an autopilot), the unit needs to be set to output NMEA data. If the NMEA output mode is set to 'Fast', the unit will output a minimum number of NMEA sentences at 1-second intervals. If the NMEA output is set to 'Normal', the unit will output a greater number NMEA sentences as 2-second intervals.

Setting NMEA output mode:

- 1) Press the **MENU** Key twice to select the Main Menu.
- 2) Turn or move the **FMS** Joystick to select 'System Setup', and press the **ENT** Key.
- 3) Turn or move the **FMS** Joystick to select 'Interface', and press the **ENT** Key.
- 4) With the 'Serial Data Format' field highlighted, turn the **FMS** Joystick to select 'NMEA In/Out'.
- 5) Move the **FMS** Joystick to highlight the 'NMEA Output Mode' field.
- 6) Turn the **FMS** Joystick to select 'Normal' or 'Fast'.

NMEA Sentence Output:

- Normal Mode: GPRMB, GPRMC, GPGGA, GPGSA, GPGSV, GPGLL, GPBWC, GPVTG, GPXTE, GPBOD, GPRTE, GPWPL, GPAPB, PGRME, PGRMZ, PGRMM, and PGRMH.
- Fast Mode: GPRMB, GPRMC, PGRMZ, and PGRMH.

CONNECTING TO A GTX 330 MODE S TRANSPONDER

To receive Mode S TIS-A traffic data from a GTX 330 transponder on your GPSMAP 695/696, connect an available RS-232 OUT pin on the transponder to the Data In pin on the GPSMAP 695/696. (You do not need to connect the transponder to the GPSMAP 695/696's Data Out pin.) Then, set the corresponding RS-232 output configuration on the transponder to REMOTE + TIS-A and set the GPSMAP 695/696's Serial Data Format to GTX TIS-A In or GTX TIS-A In/NMEA & VHF Out (refer to the Interfacing section). For more information, see Appendix E and the GTX 330 Transponder Installation Manual.

CONNECTING TO A GDL 39

To receive weather and traffic information from the GDL 39, the GDL 39 must be connected to the GPSMAP 695/696 using the 'GDL 39 Power/Data Cable to GPSMAP 695/696' (P/N 010-11686-10) or through a GDL 39 bare wire cable (P/N 010-11686-40) installation. The GPSMAP 695/696 must also be configured correctly to receive traffic and weather information from the GDL 39 as described below.

Configuring GPSMAP 695/696 for GDL 39:

- 1) Connect the GPSMAP 695/696 to the GDL 39 through the Power/Data Cable or bare wire.
- 2) Press the **MENU** Key twice to access the Main Menu.
- 3) Select 'System Setup...' and press the **ENT** Key.
- 4) Select 'Interface' and press the **ENT** Key.
- 5) With the Serial Data Format field highlighted, turn the **FMS** Joystick to select 'Garmin Data Transfer'.

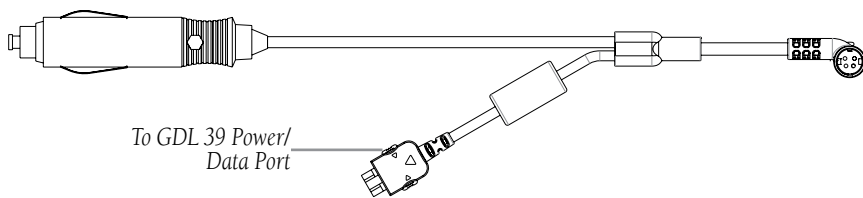

GDL 39 Power/Data Cable to GPSMAP 695/696

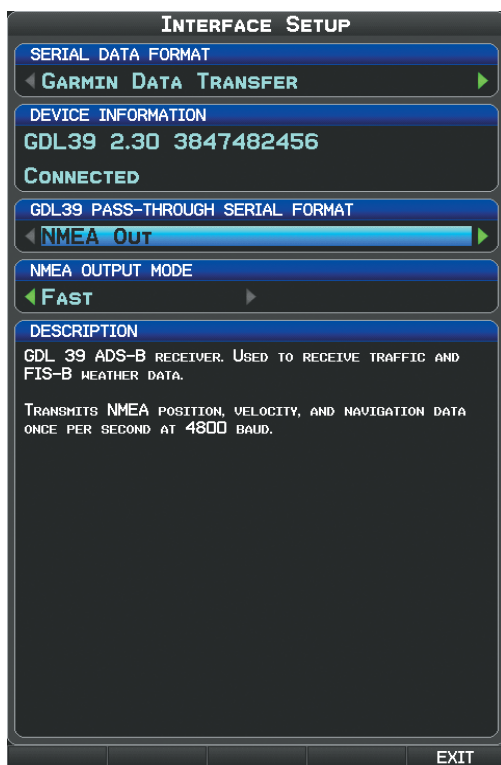

GDL 39 Interface Setup

Viewing GDL 39 Connection/Update Status:

- 1) Press the **MENU** Key twice to display the Main Menu.
- 2) Turn or move the **FMS** Joystick to highlight 'Data Link Information' and press the **ENT** Key.

Or:

- 1) From the Weather Page, press the **INFO** Softkey.



CAUTION: Never remove power from the GPSMAP 695/696 or GDL 39 during a software update. Anytime the GPSMAP 695/696 software is updated it may also contain firmware updates for products such as the GDL 39. The GPSMAP 695/696 software will update first, after the unit reboots it will update the firmware of a connected GDL 39. You can view the GDL 39 update progress on the Data Link Information Page.

DATA LINK INFORMATION	
GDL39 STATUS	
DEVICE	GDL39 2.10 3847482456
STATUS	UPDATING SOFTWARE 21%
POSITION DATA	-
PRESSURE ALTITUDE	-
GROUND UPLINK SIGNAL	-
TIS-B UPLINK SIGNAL	-
AIR-TO-AIR TRAFFIC	-

GDL 39 Update Status

GDL 39 SERIAL PASS-THROUGH



NOTE: Serial Pass-Through is only available on a bare wire installation.

The GDL 39 is capable of passing serial data from the GPSMAP 695/696 to an additional serial device. The GPSMAP 695/696 should be connected to channel A (Green, White/Green wires) on the GDL 39. To utilize the serial pass-through capability of the GDL 39, connect an additional serial device to GDL 39 channel B (Orange, White/Orange wires) and configure the serial pass-through format on the GPSMAP 695/696. On the Interface Setup Page, the following serial formats are available for GDL 39 Pass-Through:

- NMEA Out
- Aviation In
- Aviation In/NMEA & VHF Out
- GTX TIS-A In
- GTX TIS-A In/NMEA & VHF Out.
- None

Configuring aera and GDL 39 for Serial Pass-Through:

- 1) Connect the GPSMAP 695/696 to the GDL 39 through bare wire installation.
- 2) Press the **MENU** Key twice to access the Main Menu.
- 3) Select 'System Setup...' and press the **ENT** Key.
- 4) Select 'Interface' and press the **ENT** Key.
- 5) With the Serial Data Format field highlighted, turn the **FMS** Joystick to select 'Garmin Data Transfer'.
- 6) Use the **FMS** Joystick to select the GDL39 PASS-THROUGH SERIAL FORMAT ('NMEA Out', 'Aviation In', 'Aviation In/NMEA & VHF Out', 'GTX TIS-A In', 'GTX TIS-A In/NMEA & VHF Out', or 'None') to connect a secondary serial device.
- 7) If using one of the three options that includes NMEA, move the **FMS** Joystick to highlight the 'NMEA Output Mode' field.
- 8) Turn the **FMS** Joystick to select 'Normal' or 'Fast'.

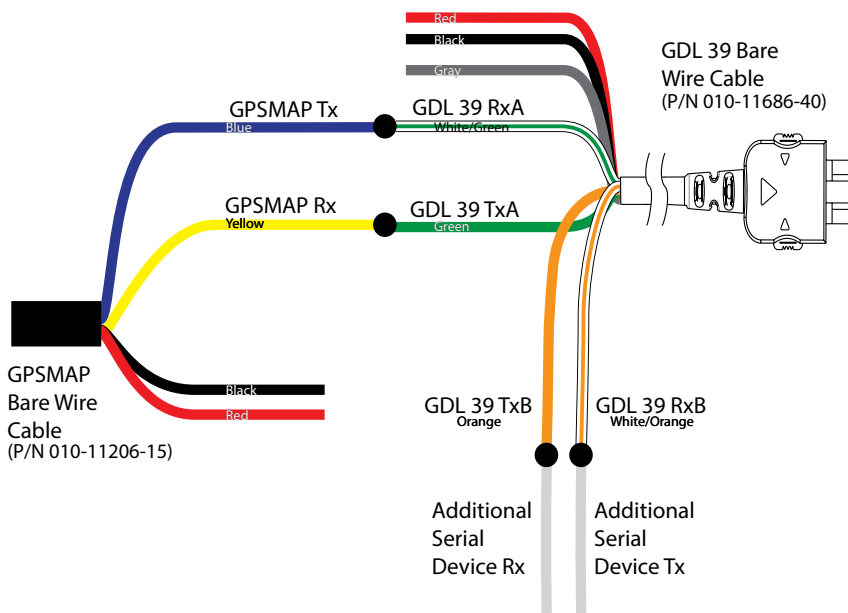

GPSMAP695/695 to GDL 39 Bare Wire Installation



NOTE: If the GDL 39 RxB (white/orange wire) is not needed in a serial-pass through installation, it should be grounded.

PIN #	Direction	Description	Wire Color
1	IN	Voltage Supply Input	Red
6		GND	Black
10	IN	Serial RxA (GDL39 IN)	White/Green
11	OUT	Serial TxA (GDL39 OUT)	Green
12	IN	Discrete Input	Gray
13	IN	Serial RxB (GDL39 IN)	White/Orange
14	OUT	Serial TxB (GDL39 OUT)	Orange

GDL 39 Bare Wire Cable Pinout (18Pin)

TIS-A INTERFACE SETUP

Configuring TIS-A input:

- 1) Press the **MENU** Key twice to select the Main Menu.
- 2) Turn or move the **FMS** Joystick to select 'System Setup', and press the **ENT** Key.
- 3) Turn or move the **FMS** Joystick to select 'Interface', and press the **ENT** Key.
- 4) With the 'Serial Data Format' field highlighted, turn the **FMS** Joystick to select 'TIS-A In' or GTX TIS-A In/NMEA & VHF Out.

The TIS-A Status field indicates one of the following messages:

- Waiting For Data—searching for a valid TIS-A data stream.
- Data Available—receiving TIS-A data from the transponder.
- Data Unavailable—connection to transponder established, but TIS-A service is unavailable.
- Lost Connection—an error occurred or the connection to the transponder was lost.

USING AN EXTERNAL GPS ANTENNA (OPTIONAL)

The optional GA25 MCX antenna can be used. Connect the antenna to the connector located on the left side of the unit.



GPSMAP 695/696 MCX Connector

Blank Page

GENERAL TIS-A INFORMATION



NOTE: Aircraft without an operational transponder are invisible to TIS-A.



WARNING: Do not rely solely upon the display of traffic information for collision avoidance maneuvering. The traffic display does not provide collision avoidance resolution advisories and does not, under any circumstances or conditions, relieve the pilot's responsibility to see and avoid other aircraft.



WARNING: Do not rely solely upon the display of traffic information to accurately depict all of the traffic within range of the aircraft. Due to lack of equipment, poor signal reception, and/or inaccurate information from aircraft or ground stations, traffic may be present that is not represented on the display.

The Traffic Information Service (TIS-A) provides traffic advisory information to non-TAS/TCAS-equipped aircraft. TIS-A is a ground-based service providing the relative locations of all ATRCBS (Air Traffic Control Radar Beacon System) Mode-A and Mode-C transponder equipped aircraft within a specified service volume. The TIS-A ground sensor uses real-time track reports to generate traffic notification. The GPSMAP 695/696 displays TIS-A traffic information on the Map Page. Surveillance data includes all transponder-equipped aircraft within the coverage volume. The GPSMAP 695/696 displays up to eight traffic targets within a 7.5-nm radius, from 3,000 feet below, to 3,500 feet above the requesting aircraft.

TIS-A VS. TAS/TCAS

The main difference between the Traffic Information System (TIS-A) and Traffic Advisory (TAS) or Traffic Collision Avoidance Systems (TCAS) is the source of surveillance data. TAS/TCAS uses an airborne interrogator with a half-second update rate, while TIS-A utilizes the terminal Mode-S ground interrogator and accompanying data link to provide a five-second update rate. TIS-A and TAS/TCAS have similar ranges.

TIS-A LIMITATIONS

TIS-A relies on surveillance of the Mode-S radar system, which is a “secondary surveillance” radar system similar to that used by ATCRBS. Many limitations are inherent in secondary radar surveillance. Information provided by TIS-A is neither better nor more accurate than the information used by ATC. TIS-A is intended only to assist in visual acquisition of other aircraft in visual meteorological conditions (VMC). While TIS-A is a useful aid for visual traffic avoidance, system limitations must be considered to ensure proper use. No recommended avoidance maneuvers are given, nor authorized, as a direct result of a TIS-A intruder display or TIS-A advisory.

- TIS-A operation may be intermittent during turns or other maneuvering.
- TIS-A is dependent on two-way, line-of-sight communications between the aircraft and the Mode-S radar antenna. Whenever the structure of the aircraft comes between the transponder antenna and the ground-based radar antenna, the signal may be temporarily interrupted.



NOTE: Refer to the *TIS-A Limitations* section of the *Aeronautical Information Manual (AIM)* for a more comprehensive explanation of limitations and anomalies associated with TIS-A.



NOTE: TIS-A is unavailable at low altitudes in many area of the United States. This is often the case in mountainous regions.



NOTE: Garmin is not responsible for Mode S geographical coverage. Operation of the ground stations is the responsibility of the FAA. Refer to the AIM for a Terminal Mode S radar site map.

TIS-A information is collected during a single radar sweep. Collected information is then sent through the Mode S uplink on the next radar sweep. Because of this, the surveillance information is approximately five seconds old. TIS-A ground station tracking software uses prediction algorithms to compensate for this delay. These algorithms use track history data to calculate expected intruder positions consistent with the time of display. Occasionally, aircraft maneuvering may cause variations in this calculation and create slight errors on the Map Page which affect relative bearing information and

the target track vector and may delay display of the intruder information. However, intruder distance and altitude typically remain relatively accurate and may be used to assist in spotting traffic. The following errors are common examples:

- When the client or intruder aircraft maneuvers excessively or abruptly, the tracking algorithm may report incorrect horizontal position until the maneuvering aircraft stabilizes.
- When a rapidly closing intruder is on a course that intercepts the client aircraft course at a shallow angle (either overtaking or head-on) and either aircraft abruptly changes course within 0.25 nm, TIS-A may display the intruder aircraft on the incorrect side of the client aircraft.

These are rare occurrences and are typically resolved within a few radar sweeps once the client/intruder aircraft course stabilizes.

Pilots using TIS-A can provide valuable assistance in the correction of malfunctions by reporting observations of undesirable performance. Reports should identify the time of observation, location, type and identity of the aircraft, and describe the condition observed. Reports should also include the type of transponder and transponder software version. Since TIS-A performance is monitored by maintenance personnel, not ATC, malfunctions should be reported in the following ways:

- By telephone to the nearest Flight Service Station (FSS) facility
- By FAA Form 8000-7, Safety Improvement Report (postage-paid card can be obtained at FAA FSSs, General Aviation District Offices, Flight Standards District Offices, and General Aviation Fixed Base Operators)

Blank Page

UTILITIES

FLIGHT LOG

The Flight Log shows a list of any recorded flights, including date, route of flight, and flight time. The GPSMAP 695/696 saves up to 50 recorded flights. Entries on this list are automatically created for each flight.

An optional FlightBook software package is available to further simplify your flight record keeping. For details about FlightBook, visit the Garmin Web site at www.garmin.com/aviation.

Recording begins when your speed exceeds 30 knots and you gain 250 feet of altitude. If you land and groundspeed drops below 30 knots, the flight entry is saved and a new entry is recorded when you depart the airport. A touch-and-go or brief stop of less than 10 minutes appends to the current flight record, rather than starting a new entry.

VIEWING THE FLIGHT LOG

Select any listed entry in the log to view additional information, including a map displaying the actual path flown.

Viewing details for a flight:

- 1) Press the **MENU** Key twice to display the Main Menu.
- 2) Turn or move the **FMS** Joystick to select 'Flight Log', and press the **ENT** Key. (Hours and minutes can be displayed by pressing the **MENU** Key and selecting 'Show Hours and Minutes').
- 3) Turn or move the **FMS** Joystick to select the desired flight from the list, and press the **ENT** Key. Route, date, hours, distance, and actual flight path is displayed.
- 4) With 'Done' selected, press the **ENT** Key to return to the previous page.

FLIGHT LOG		
11-JUN	KMCI-KSTJ	0.2 HOURS
11-JUN	K50-KEGT	0.1 HOURS
11-JUN	51K-K34	0.4 HOURS
10-JUN	KOJC-KLWC	0.2 HOURS

Flight Log List



Flight Log Review

DELETING FLIGHT RECORDS

You can delete the highlighted flight record or delete all flight records from the Flight Log.

Deleting flight records:

- 1) Press the **MENU** Key twice to display the Main Menu.
- 2) Turn or move the **FMS** Joystick to select 'Flight Log', and press the **ENT** Key.
- 3) Select the desired flight (if applicable), and press the **MENU** Key.
- 4) Turn or move the **FMS** Joystick to select 'Delete Flight' or 'Delete All', and press the **ENT** Key.

TRACK LOG

The GPSMAP 695/696 draws an electronic breadcrumb trail or "track log" on the Map Page. The track log contains points along its path, including time, and location for each point.

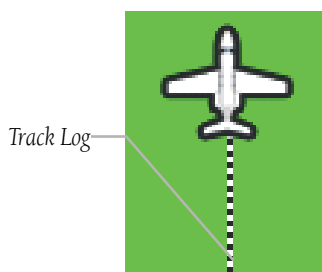

Track Log (Map Page)

The track log starts recording as soon as the GPSMAP 695/696 gets a location fix. For the best results, clear the track log before each flight. When the track log is full, new track points overwrite the oldest track points (if set to 'Wrap' in the Track Log Settings).

The percentage of memory used by the current track log appears at the top of the Track Log Window. After the track log is cleared, it shows zero percent. When the screen reaches 100%, the most recent track points start to overwrite the least recent track points (if 'Wrap' is selected in the Record Mode Field). To avoid losing track points, save the track log when it approaches the 99% mark.

The Save feature allows storage of up to 15 track logs.

Displaying/removing the track log on the Map Page:

- 1) From the Map Page, press the **MENU** Key. The Map Page Menu is displayed.
- 2) Turn or move the **FMS** Joystick to select 'Set Up Map' from the Map Page Menu, and press the **ENT** Key.
- 3) Turn the **FMS** Joystick to highlight the 'Line' options from the horizontal list.
- 4) Move the **FMS** Joystick to highlight the 'Track Log' field.
- 5) Turn the **FMS** Joystick to select 'On' or 'Off', and press the **ENT** Key.
- 6) Press the **FMS** Joystick, the **CLR** Key, or the **EXIT** Softkey to return to the Map Page.

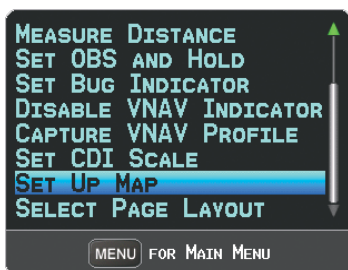

Map Page Menu

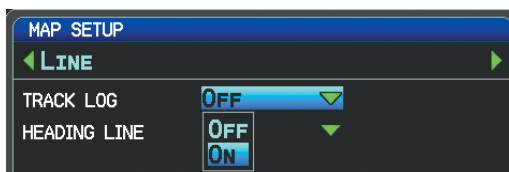

Map Setup Page

Changing track log settings:

- 1) Press the **MENU** Key twice.
- 2) Turn or move the **FMS** Joystick to select 'Track Log' from the Main Menu, and press the **ENT** Key.
- 3) Move the **FMS** Joystick to highlight the desired field.
- 4) Turn the **FMS** Joystick to select the desired setting.

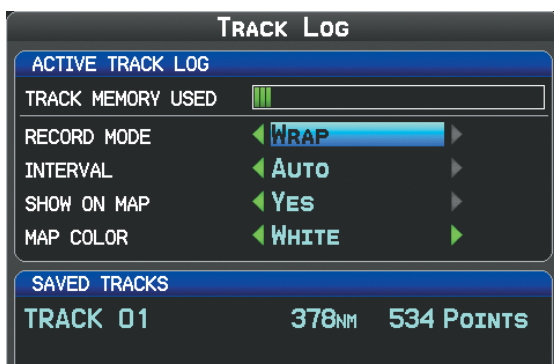
Track Log Window

- Record Mode—'Wrap' records over the oldest tracks when the track log reaches 100%. 'Fill' records a track log until the track log is full (100%).
- Interval—'Distance' records track points after a specified distance has been traveled. 'Time' creates track points after a specified time has elapsed.
- Show On Map—Select 'Yes' to display the track log on the map.
- Map Color—Select a color for the track when it appears on the map.

Clearing the track log:

- 1) Press the **MENU** Key twice.
- 2) Turn or move the **FMS** Joystick to select 'Track Log' from the Main Menu, and press the **ENT** Key.
- 3) Move the **FMS** Joystick to highlight the desired saved track, and press the **CLEAR** Softkey. (Or press the **MENU** Key, with 'Clear Active Track' selected, press the **ENT** Key.) The 'Clear Active Track Log?' window is displayed.
- 4) With 'Yes' selected, press the **ENT** Key.

Saving a track log:

- 1) Press the **MENU** Key twice.
- 2) Turn or move the **FMS** Joystick to select 'Track Log' from the Main Menu, and press the **ENT** Key.
- 3) Press the **SAVE** Softkey. (Or press the **MENU** Key, with 'Save Active Track' selected, press the **ENT** Key.) The 'Save Active Track?' window is displayed.

- 4) Turn the **FMS** Joystick to select 'Entire Active Track', 'Past 24 Hours', 'Past 7 Days', or 'Specify Dates'.
- 5) Move the **FMS** Joystick to highlight 'Save' and press the **ENT** Key.

Editing a track log:

- 1) Press the **MENU** Key twice.
- 2) Turn or move the **FMS** Joystick to select 'Track Log' from the Main Menu, and press the **ENT** Key.
- 3) Move the **FMS** Joystick to highlight the desired saved track, and press the **ENT** Key.
- 4) Move the **FMS** Joystick to highlight the desired field.
- 5) Turn the **FMS** Joystick to make the desired changes.
- 6) With 'Done' selected, press the **ENT** Key.

Exporting a track log:

- 1) Press the **MENU** Key twice.
- 2) Turn or move the **FMS** Joystick to select 'Track Log' from the Main Menu, and press the **ENT** Key.
- 3) Using the **FMS** Joystick highlight the desired track log to export.
- 4) With an SD card inserted, press the **EXPORT** Softkey.

HEADING LINE

The GPSMAP 695/696 draws an electronic "heading line" on the Map Page. The heading line can be set to time or distance.

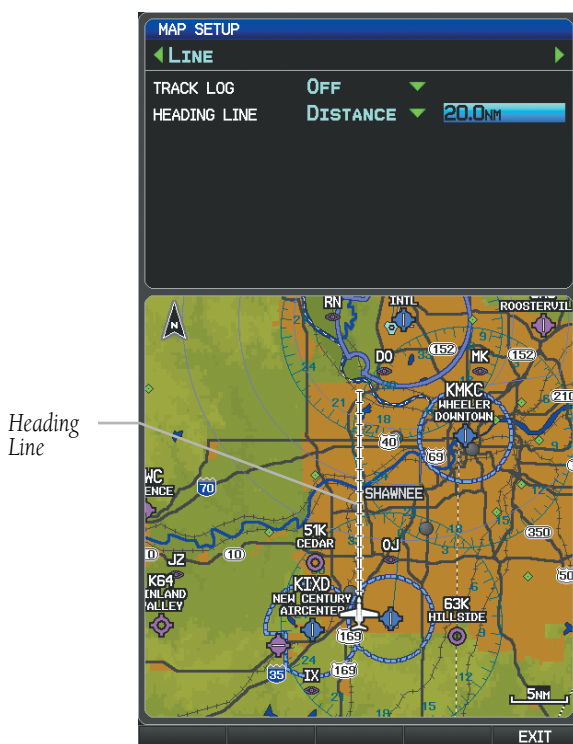

Heading Line (Map Setup Page Menu)

Changing the heading line settings on the Map Page:

- 1) From the Map Page, press the **MENU** Key. The Map Page Menu is displayed.
- 2) Turn or move the **FMS** Joystick to select 'Set Up Map' from the Map Page Menu, and press the **ENT** Key.
- 3) Turn the **FMS** Joystick to highlight the 'Line' options from the horizontal list.
- 4) Move the **FMS** Joystick to highlight the 'Heading Line' field.
- 5) Turn the **FMS** Joystick to select 'On/Off', 'Distance', or 'Time' and press the **ENT** Key. If necessary, move the **FMS** Joystick to set the desired time or distance, and press the **ENT** Key.
- 6) Press the **FMS** Joystick, the **CLR** Key, or the **EXIT** Softkey to return to the Map Page.

E6B CALCULATOR

The E6B Calculator in the Main Menu calculates Density Altitude, True Airspeed, and Winds Aloft (Head Wind, Tail Wind, Wind From, and Wind Speed), based on information you enter.

Accessing the E6B calculator:

- 1) Press the **MENU** Key twice to open the Main Menu.
- 2) Turn or move the **FMS** Joystick to highlight 'E6B Calculator', and press the **ENT** Key. The E6B Calculator Page is displayed.

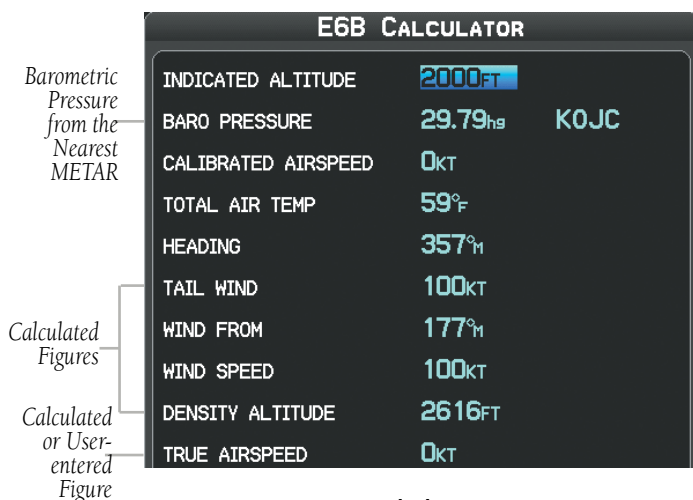

E6B Calculator Page

- **Indicated Altitude**—required entry for density altitude/true airspeed calculation. Enter the aircraft's altimeter reading. A suggested indicated altitude will be displayed based on the GPS altitude.
- **Baro Pressure**—when the unit is receiving SiriusXM weather information, the field automatically updates to the barometric pressure of the nearest METAR. If SiriusXM weather information is not available you need to enter the current barometric pressure.
- **Calibrated Airspeed**— required entry for density altitude/true airspeed calculation. Enter the aircraft's airspeed indicator value.
- **Total Air Temp**— required entry for density altitude/true airspeed calculation. Total Air Temperature (TAT) is the temperature of the air including the heating effect caused

by speed. The temperature reading on a standard outside air temperature gauge found on most piston aircraft is TAT.

- **Heading**— required entry for winds aloft calculation. Use heading from the aircraft's heading indicator or directional gyro.
- **Tail Wind**— (calculated figure) determined from entry of heading and true airspeed.
- **Wind From**—(calculated figure) determined from entry of heading and true airspeed.
- **Wind Speed**—(calculated figure) determined from entry of heading and true airspeed.
- **Density Altitude**— (calculated figure) determined from entry of indicated altitude, barometric pressure and total air temperature.
- **True Airspeed**— (calculated or user-entered figure) determined from entry of calibrated airspeed, barometric pressure, and total air temperature. This can also be entered directly for winds aloft calculations.

Calculating true airspeed and density altitude:

- 1) From the E6B Calculator Page, enter the altitude shown on the altimeter into the 'Indicated Altitude' field, and press the **ENT** Key.
- 2) Repeat for 'Calibrated Airspeed', 'Baro Pressure', and 'Total Air Temperature' fields. (For Calibrated Airspeed, use the speed shown on the airspeed indicator. Use the current altimeter setting for Baro Pressure. Total Air Temperature is the temperature of the outside air including the heating effect caused by speed. For most aircraft, this is the temperature reading on a standard outside air temperature gauge.) The calculated figures for True Airspeed and Density Altitude are shown in the designated fields.

Calculating winds aloft:

- 1) Calculate or enter the true airspeed into the 'True Airspeed' field, and press the **ENT** Key.
- 2) Enter the aircraft heading shown on the directional gyro or compass into the 'Heading' field, and press the **ENT** Key. Head/Tail Wind, Wind From, and Wind Speed are calculated.



NOTE: If True North is selected as the heading reference, a heading referenced to True North must be used to calculate winds accurately.

Restoring E6B calculator defaults:

- 1) From the E6B Calculator Page, press the **MENU** Key.
- 2) With 'Restore Default' highlighted, press the **ENT** Key.

AIRCRAFT PROFILE

The Aircraft Profile Page allows the pilot to select cruising speed, maximum speed, fuel flow, and map symbol. The unit can save up to 10 aircraft profiles.

The maximum speed is used to define the range for airspeed on the Panel and is automatically updated if you exceed this figure.

Accessing the aircraft profile:

- 1) Press the **MENU** Key twice to open the Main Menu.
- 2) Turn or move the **FMS** Joystick to highlight 'Aircraft Profile', and press the **ENT** Key.

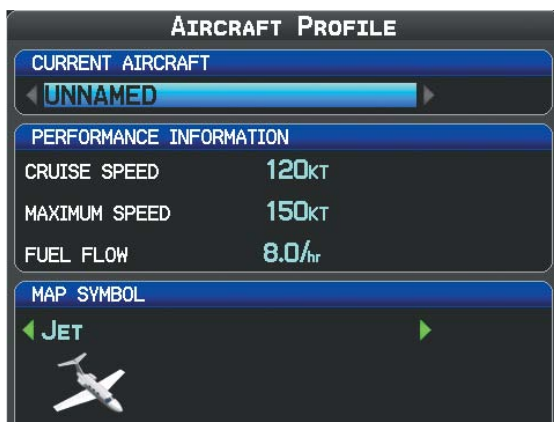

Aircraft Profile Page

Entering an aircraft profile:

- 1) From the Aircraft Profile Page, press the **NEW** Softkey. The cursor is activated in the 'Current Aircraft' field.
- 2) Enter the desired aircraft name, and press the **ENT** Key.
- 3) Move the **FMS** Joystick to the 'Cruise Speed' field, turn the **FMS** Joystick to enter the appropriate cruise speed, and press the **ENT** Key. Repeat for the 'Maximum Speed' and 'Fuel Flow' fields.
- 4) Move the **FMS** Joystick to highlight the 'Map Symbol' field, and turn the **FMS** Joystick to select the desired map symbol.

Selecting a saved aircraft profile:

- 1) From the Aircraft Profile Page, highlight the 'Current Aircraft' field.
- 2) Turn the **FMS** Joystick to select the desired saved aircraft profile.

Renaming a saved aircraft profile:

- 1) From the Aircraft Profile Page, highlight the 'Current Aircraft' field.
- 2) Turn the **FMS** Joystick to select the desired aircraft profile to be renamed.
- 3) Press the **RENAME** Softkey. The cursor is activated in the 'Current Aircraft' field.
- 4) Enter the desired name in the 'Current Aircraft' field, and press the **ENT** Key.

Deleting a saved aircraft profile:

- 1) From the Aircraft Profile Page, highlight the 'Current Aircraft' field.
- 2) Turn the **FMS** Joystick to select the desired aircraft profile to be deleted.
- 3) Press the **DELETE** Softkey. The 'XXXXXX Will Be Deleted' window is displayed.
- 4) With 'OK' highlighted, press the **ENT** Key.

WEIGHT & BALANCE

Weight & Balance may be used during pre-flight preparations to verify the weight and balance conditions of the aircraft. By entering the weight and arm values on this page, the GPSMAP 695/696 can calculate the total weight, moment, and center of gravity (CG).

Before entering the various figures, the empty weight of the airplane and the arm (or "station") for each weight should be determined. These figures should be determined using the pilot's operating handbook for the airplane, which also notes the weight limitations and fore/aft CG limits. Compare those figures to the values calculated by the GPSMAP 695/696.

To perform weight and balance calculations:

- 1) Press the **MENU** Key twice to open the Main Menu.
- 2) Turn or move the **FMS** Joystick to highlight 'Weight & Balance', and press the **ENT** Key.
- 3) Select the desired aircraft from the 'Current Aircraft' field.
- 4) Use the **FMS** Joystick to enter the desired weights and arms (or "stations"), pressing the **ENT** Key after each entry. The calculated moment, weight, and CG figures appear at the bottom of the page. Keep in mind that the "Aircraft" (empty weight/arm) figures must be entered as a reference to calculate a valid moment, weight, and CG.
- 5) To empty the aircraft, press the Menu Key and select 'Empty Aircraft', or press the **EMPTY** Softkey.



NOTE: This information is only for flight planning purposes. Consult the aircraft's pilot operating handbook for the official weight and balance data.

WEIGHT & BALANCE		
CURRENT AIRCRAFT		
◀ UNNAMED ▶		
	WEIGHT	ARM
AIRCRAFT	1151 LB	+30.00
USABLE FUEL	147 LB	0.00
PILOT	180 LB	+39.00
CO-PILOT	180 LB	+39.00
PASSENGER	0 LB	0.00
PASSENGER	0 LB	0.00
BAGGAGE	50 LB	+84.00
OTHER	0 LB	0.00
OTHER	0 LB	0.00
TOTALS		
MOMENT	52770	
WEIGHT	1708 LB	
C.G.	+30.90	

Weight & Balance

EPE CIRCLE

Estimated Position Error (EPE) indicates the accuracy of the position fix. EPE uses Dilution of Precision (DOP) and other factors to calculate a horizontal position error. DOP measures satellite geometry quality (i.e., number of satellites received and where they are relative to each other).

Setting up and customizing the EPE circle for the map page:

- 1) From the Map Page press the **MENU** Key.
- 2) Turn or move the **FMS** Joystick to highlight 'Set Up Map' and press the **ENT** Key.
- 3) Turn the **FMS** Joystick to select the 'Miscellaneous' from the horizontal list.
- 4) Move the **FMS** Joystick to highlight the desired feature.
- 5) Turn the **FMS** Joystick to select 'On' or 'Off', and press the **ENT** Key.

PROXIMITY WAYPOINTS

The Proximity Waypoints Page allows the pilot to define an alarm circle around a waypoint location.

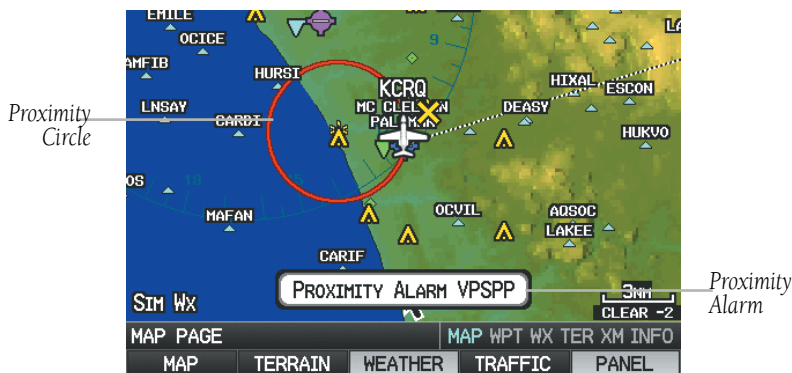

Proximity Waypoint Alarm

Defining proximity waypoints:

- 1) Press the **MENU** Key twice to open the Main Menu.
- 2) Turn or move the **FMS** Joystick to highlight 'User Waypoints', and press the **ENT** Key.
- 3) Press the **PROXIMITY** Softkey. The Proximity Waypoints Page is displayed.
- 4) Press the **NEW** Softkey. The New Proximity Waypoint Window is displayed.
- 5) Select 'Use Map' or 'Use Identifier', and press the **ENT** Key.
- 6) Select the desired waypoint using the Map or Select Waypoint Window, and press the **ENT** Key. The 'Distance' field is highlighted.
- 7) Using the **FMS** Joystick, enter the desired distance and press the **ENT** Key.

Setting up and customizing proximity waypoints for the map page:

- 1) Press the **MENU** Key twice to open the Main Menu.
- 2) Turn or move the **FMS** Joystick to highlight 'User Waypoints', and press the **ENT** Key.
- 3) Press the **PROXIMITY** Softkey. The Proximity Waypoints Page is displayed.
- 4) Turn the **FMS** Joystick to select 'On' or 'Off', and press the **ENT** Key.

Or:

- 1) From the Map Page press the **MENU** Key.
- 2) Turn or move the **FMS** Joystick to highlight 'Set Up Map' and press the **ENT** Key.
- 3) Turn the **FMS** Joystick to select the 'Point' from the horizontal list.
- 4) Move the **FMS** Joystick to highlight the 'Proximity Circle' Field.
- 5) Turn the **FMS** Joystick to access a list of options for each feature (On/Off, Auto, or range settings).
- 6) Highlight the desired setting and press the **ENT** Key.

Deleting proximity waypoints:

- 1) Press the **MENU** Key twice to open the Main Menu.
- 2) Turn or move the **FMS** Joystick to highlight 'User Waypoints', and press the **ENT** Key.
- 3) Press the **PROXIMITY** Softkey. The Proximity Waypoints Page is displayed.
- 4) Press the **CLR** Key or the **MENU** Key and select 'Remove Selected Waypoint' or 'Remove All Waypoints'.
- 5) Press the **ENT** Key. The 'Remove Proximity Waypoint for XXXX' Window is displayed
- 6) With 'Yes' highlighted, press the **ENT** Key.

Overview

GPS Navigation

Flight Planning

Hazard Avoidance

Additional Features











Appendices

Index







Blank Page

DISPLAY SYMBOLS









VFR SYMBOLS

Item	Symbol
Unknown	
Non-towered, Non-serviced	
Towered, Non-serviced	
Non-towered, Serviced	
Towered, Serviced	
Soft Surface, Non-serviced	
Soft Surface, Serviced	
Soft Surface, Private	
Paved, Private	
Seaplane Base	
Heliport	



Americas/Pacific Database Airports

Item	Symbol
Civilian, Non-serviced	
Military, Non-serviced	
Civilian, Serviced	
Military, Serviced	
Civilian, Soft/Unknown Surface, Non-serviced	
Civilian, Soft/Unknown Surface, Serviced	

Atlantic Database Airports



Item	Symbol
Intersection	
Visual Reporting Point	
LOM (compass locator at outer marker)	
NDB (non-directional radio beacon)	
VOR	
VOR/DME	
ILS/DME or DME only	
VORTAC	
TACAN	

Nav aids



Item	Symbol
Interstate Highway	
US Highway	
State Highway	
National Highway	
Small City	
Medium City	
Large City	

Miscellaneous

IFR SYMBOLS

Item	Symbol
VFR, Soft/unknown Surface, Non-serviced	
VFR, Soft/unknown Surface, Serviced	

Atlantic Database Airports

Item	Symbol
Low-Altitude	
High-Altitude	

Airways

Item	Symbol
Unknown	
VFR Airport, Non-serviced	
IFR Airport, Non-serviced	
VFR Airport, Serviced	
IFR Airport, Serviced	
VFR, Soft Surface, Non-serviced	
VFR, Soft Surface, Serviced	
VFR, Soft Surface, Private	
VFR, Paved, Private	
VFR Seaplane Base	
VFR Heliport	

Americas/Pacific Database Airports

Item	Symbol
Intersection	
LOM (compass locator at outer marker)	
NDB (non-directional radio beacon)	
VOR	
VOR/DME	
ILS/DME or DME Only	
VORTAC	
TACAN	

Nav aids



AIRSPACE SYMBOLS

Item	Symbol
Class B, Class E, CTA	
Class A, Class C, TMA	
Class D	
Mode C Veil	
TRSA	
MOA	
Danger, Alert, or Training Area	
Restricted, Prohibited, or Warning Area	
Radar Area	
ATZ, TIZ	
MATZ	
ADIZ	
Misc/Unknown	

VFR Americas/Pacific Database

Item	Symbol
Class B, Class E, CTA	
Class A, Class C, TMA, TRSA	
Class D	
MOA	
Danger, Alert, or Training Area	
Restricted, Prohibited, or Warning Area	
Radar Area	
ATZ, TIZ	
Misc/Unknown	

IFR Americas/Pacific Database

Item	Symbol
Danger or Alert Area	
Restricted, Prohibited, or Warning Area	
Training Area	

VFR Atlantic Database Exceptions

Item	Symbol
Training Area	

IFR Atlantic Database Exceptions

Overview

GPS Navigation

Flight Planning

Hazard Avoidance

Additional Features

Appendices

Index

Blank Page

MAP DATUM AND LOCATION FORMATS

MAP DATUMS

A datum is a mathematical model of the Earth that approximates the shape of the Earth and enables calculations to be carried out in a consistent and accurate manner. The datum is physically represented by a framework of ground monuments (such as trig. stations) whose locations have been accurately measured and calculated on this reference surface. Lines of latitude and longitude on a chart are referenced to a specific map datum. Every chart has a map datum reference and the GPSMAP 695/696 can be set to match most of those commonly used.

LOCATION FORMATS

Your current location can be viewed on the GPS in the form of coordinates. Since different charts use different location formats, Garmin GPS units allow you to choose the correct coordinate system for the type of chart you are using. The most common format is latitude and longitude, which is used by all Garmin units. You can change the location format to use with other coordinate systems. Several other grids, including a user-definable grid (for the advanced user), are available.

Blank Page

GLOSSARY

ADIZ	Air Defense Identification Zone
ADS-B	Automatic Dependant Surveillance -Broadcast
ADS-B In	Ability to receive ADS-B information from other aircraft and Ground Based Transceivers (GBTs)
ADS-B Out	Ability to transmit ADS-B data on 1090 ES or 978 MHz
ADS-B Participating Aircraft	An aircraft that has both ADS-B In and ADS-B Out capabilities.
ADS-R	Automatic Dependent Surveillance-Rebroadcast
AFM	Airplane Flight Manual
AGL	Above Ground Level
AIM	Airman's Information Manual
AIRMET	Airman's Meteorological Information
APT	airport
ASPC	airspace
ARTCC	Air Route Traffic Control Center
ASOS	Automated Surface Observing System
ATC	Air Traffic Control
ATIS	Automatic Terminal Information Service
AWOS	Automated Weather Observing System
Bearing	The compass direction from the present position to a destination waypoint.
°C	degrees Celsius
Calibrated Airspeed	Indicated airspeed corrected for installation and instrument errors.
cm	centimeter
COM	communication radio
Course	The line between two points to be followed by the aircraft.

Course to Steer The recommended direction to steer in order to reduce course error or stay on course. Provides the most efficient heading to get back to the desired course and proceed along the flight plan.

Crosstrack Error The distance the aircraft is off a desired course in either direction, left or right.

CTS Course to Steer

dBZ decibels 'Z' (radar return)

deg degree

Desired Track The desired course between the active "from" and "to" waypoints.

DIS distance

Distance The 'great circle' distance from the present position to a destination waypoint.

DME Distance Measuring Equipment

DTK Desired Track

Enroute Safe Altitude The recommended minimum altitude within ten miles left or right of the desired course on an active flight plan or direct-to.

ENT enter

ESA Enroute Safe Altitude

Estimated Time of Arrival The estimated time at which the aircraft should reach the destination waypoint, based upon current speed and track.

Estimated Time Enroute The estimated time it takes to reach the destination waypoint from the present position, based upon current ground speed.

ETA Estimated Time of Arrival

ETE Estimated Time Enroute

°F degrees Fahrenheit

FAA	Federal Aviation Administration
FAF	Final Approach Fix
FCC	Federal Communication Commission
FPL	flight plan
fpm	feet per minute
FSS	Flight Service Station
ft	foot/feet
gal	gallon(s)
geodetic altitude	GPS calculated altitude
Glide Ratio, G/R	The estimated distance an aircraft will move forward for any given amount of lost altitude.
GND	ground
gph	gallons per hour
GPS	Global Positioning System
Grid MORA	Grid Minimum Off-Route Altitude; one degree latitude by one degree longitude in size and clears the highest elevation reference point in the grid by 1000 feet for all areas of the grid
Ground-Based Transceiver	Provides ADS-R, TIS-B and FIS-B broadcasts to ADS-B participating aircraft.
Groundspeed	The velocity that the aircraft is travelling relative to a ground position.
Ground Track	see Track
GS	Ground speed
Heading	The direction an aircraft is pointed, based upon indications from a magnetic compass or a properly set directional gyro.
Hg	mercury
hPa	hectopascal

Overview

hr	hour
HSI	Horizontal Situation Indicator
Hz	Hertz

GPS Navigation

IAF	Initial Approach Fix
IAT	Indicated Air Temperature
ICAO	International Civil Aviation Organization
IFR	Instrument Flight Rules

Flight Planning

ILS	Instrument Landing System
IMC	Instrument Meteorological Conditions
in	inch
Indicated	Information provided by properly calibrated and set instrumentation on the aircraft panel.

Hazard Avoidance

in HG	inches of mercury
-------	-------------------

Additional Features

kg	kilogram
kHz	kilohertz
km	kilometer
kt	knot

Appendices

LAT	latitude
lb	pound
Leg	The portion of a flight plan between two waypoints.
LOC	localizer
LON	longitude

Index

m	meter
MAP	Missed Approach Point
METAR	Meteorological Aviation Routine

MHz	megahertz
Minimum Safe Altitude	Uses Grid MORAs to determine a safe altitude within ten miles of the aircraft present position.
MOA	Military Operations Area
MSA	Minimum Safe Altitude
MSL	Mean Sea Level
NAVAID	NAVigation AID
NDB	Non-directional Beacon
NEXRAD	Next Generation Radar
nm	nautical mile(s)
NRST	nearest
OAT	Outside Air Temperature
OBS	Omni Bearing Selector
psi	pounds per square inch
QTY	quantity
rpm	revolutions per minute
SBAS	Satellite-Based Augmentation System
SD	Secure Digital
sec	second(s)
SIGMET	Significant Meteorological Information
TA	Traffic Advisory
TACAN	Tactical Air Navigation System
TAF	Terminal Aerodrome Forecast

Overview

TAS	True Airspeed
TCAS	Traffic Collision Avoidance System
TER	terrain
TFR	Temporary Flight Restriction

GPS Navigation

TIS-A	Traffic Information Service
TIS-B	Traffic Information Service-Broadcast

TOPO	topographic
Track	Direction of aircraft movement relative to a ground position; also 'Ground Track'

Flight Planning

TRSA	Terminal Radar Service Area
------	-----------------------------

UTC	Coordinated Universal Time
-----	----------------------------

Hazard Avoidance

VFR	Visual Flight Rules
VHF	Very High Frequency
VNAV	vertical navigation
VOL	volume

Additional Features

VOR	VHF Omni-directional Range
VORTAC	very high frequency omnidirectional range station and tactical air navigation

Appendices

VSI	Vertical Speed Indicator
VSR	Vertical Speed Required
VTF	vector to final

WAAS	Wide Area Augmentation System
WPT	waypoint
WX	weather

Index

XTK	Crosstrack Error
-----	------------------

LICENSE AGREEMENT AND WARRANTY

CONTACT GARMIN

Contact Garmin if you have any questions while using your GPSMAP 695/696. In the USA contact Garmin Product Support by phone: (913) 397-8200 or (800) 800-1020, Monday–Friday, 8 AM–5 PM Central Time; or go to www.garmin.com/support.

In Europe, contact Garmin (Europe) Ltd. at +44 (0) 870.8501241 (outside the UK) or 0808 2380000 (within the UK).

SOFTWARE LICENSE AGREEMENT

BY USING THE GPSMAP 695/696, YOU AGREE TO BE BOUND BY THE TERMS AND CONDITIONS OF THE FOLLOWING SOFTWARE LICENSE AGREEMENT. PLEASE READ THIS AGREEMENT CAREFULLY.

Garmin grants you a limited license to use the software embedded in this device (the “Software”) in binary executable form in the normal operation of the product. Title, ownership rights, and intellectual property rights in and to the Software remain with Garmin.

You acknowledge that the Software is the property of Garmin and is protected under the United States of America copyright laws and international copyright treaties. You further acknowledge that the structure, organization, and code of the Software are valuable trade secrets of Garmin and that the Software in source code form remains a valuable trade secret of Garmin. You agree not to decompile, disassemble, modify, reverse assemble, reverse engineer, or reduce to human readable form the Software or any part thereof or create any derivative works based on the Software. You agree not to export or re-export the Software to any country in violation of the export control laws of the United States of America.

LIMITED WARRANTY

This Garmin product is warranted to be free from defects in materials or workmanship for one year from the date of purchase. Within this period, Garmin will, at its sole option, repair or replace any components that fail in normal use. Such repairs or replacement will be made at no charge to the customer for parts or labor, provided that the customer shall be responsible for any transportation cost. This warranty does not cover failures due to abuse, misuse, accident, or unauthorized alteration or repairs. In addition, Garmin reserves the right to refuse warranty claims against products or services that are obtained and/or used in contravention of the laws of any country.

This product is intended to be used only as a travel aid and must not be used for any purpose requiring precise measurement of direction, distance, location, or topography. Garmin makes no warranty as to the accuracy or completeness of map data in this product.

THE WARRANTIES AND REMEDIES CONTAINED HEREIN ARE EXCLUSIVE AND IN LIEU OF ALL OTHER WARRANTIES EXPRESS, IMPLIED, OR STATUTORY, INCLUDING ANY LIABILITY ARISING UNDER ANY WARRANTY OF MERCHANTABILITY OR FITNESS FOR A PARTICULAR PURPOSE, STATUTORY OR OTHERWISE. THIS WARRANTY GIVES YOU SPECIFIC LEGAL RIGHTS, WHICH MAY VARY FROM STATE TO STATE.

IN NO EVENT SHALL GARMIN BE LIABLE FOR ANY INCIDENTAL, SPECIAL, INDIRECT, OR CONSEQUENTIAL DAMAGES, WHETHER RESULTING FROM THE USE, MISUSE, OR INABILITY TO USE THIS PRODUCT OR FROM DEFECTS IN THE PRODUCT. SOME STATES DO NOT ALLOW THE EXCLUSION OF INCIDENTAL OR CONSEQUENTIAL DAMAGES, SO THE ABOVE LIMITATIONS MAY NOT APPLY TO YOU.

Garmin retains the exclusive right to repair or replace the unit or software or offer a full refund of the purchase price at its sole discretion. SUCH REMEDY SHALL BE YOUR SOLE AND EXCLUSIVE REMEDY FOR ANY BREACH OF WARRANTY.

To obtain warranty service, contact your local Garmin authorized dealer or call Garmin Product Support for shipping instructions and an RMA tracking number. Securely pack the unit and a copy of the original sales receipt, which is required as the proof of purchase for warranty repairs. Write the tracking number clearly on the outside of the package. Send the unit, freight charges prepaid, to any Garmin warranty service station.

Online Auction Purchases: Products sold through online auctions are not eligible for rebates or other special offers from Garmin. Online auction confirmations are not accepted for warranty verification. To obtain warranty service, an original or copy of the sales receipt from the original retailer is required. Garmin will not replace missing components from any package purchased through an online auction.

International Purchases: A separate warranty is provided by international distributors for units purchased outside the United States. This warranty is provided by the local in-country distributor and this distributor provides local service for your unit. Distributor warranties are only valid in the area of intended distribution. Units purchased in the United States or Canada must be returned to the Garmin service center in the United Kingdom, the United States, Canada, or Taiwan for service.

AOPA AIRPORT DIRECTORY NOTICE

AOPA MEMBERSHIP PUBLICATIONS, INC. AND ITS RELATED ORGANIZATIONS (HEREINAFTER COLLECTIVELY "AOPA") EXPRESSLY DISCLAIM ALL WARRANTIES, WITH RESPECT TO THE AOPA INFORMATION INCLUDED IN THIS DATA, EXPRESS OR IMPLIED, INCLUDING, BUT NOT LIMITED TO, THE IMPLIED WARRANTIES OF MERCHANTABILITY AND FITNESS FOR A PARTICULAR PURPOSE. THE INFORMATION IS PROVIDED "AS IS" AND AOPA DOES NOT WARRANT OR MAKE ANY REPRESENTATIONS REGARDING ITS ACCURACY, RELIABILITY, OR OTHERWISE. UNDER NO CIRCUMSTANCES INCLUDING NEGLIGENCE, SHALL AOPA BE LIABLE FOR ANY INCIDENTAL, SPECIAL OR CONSEQUENTIAL DAMAGES THAT RESULT FROM THE USE OR INABILITY TO USE THE SOFTWARE OR RELATED DOCUMENTATION, EVEN IF AOPA OR AN AOPA AUTHORIZED REPRESENTATIVE HAS BEEN ADVISED OF THE POSSIBILITY OF SUCH DAMAGES. USER AGREES NOT TO SUE AOPA AND, TO THE MAXIMUM EXTENT ALLOWED BY LAW, TO RELEASE AND HOLD HARMLESS AOPA FROM ANY CAUSES OF ACTION, CLAIMS OR LOSSES RELATED TO ANY ACTUAL OR ALLEGED INACCURACIES IN THE INFORMATION ARISING OUT OF GARMIN'S USE OF THE INFORMATION IN THE DATASETS. SOME JURISDICTIONS DO NOT ALLOW THE LIMITATION OR EXCLUSION OF IMPLIED WARRANTIES OR LIABILITY FOR INCIDENTAL OR CONSEQUENTIAL DAMAGES SO THE ABOVE LIMITATIONS OR EXCLUSIONS MAY NOT APPLY TO YOU.

AC-U-KWIK LICENSE AGREEMENT

AC-U-KWIK AND ITS RELATED ORGANIZATIONS (HEREINAFTER COLLECTIVELY "AC-U-KWIK ORGANIZATIONS") EXPRESSLY DISCLAIM ALL WARRANTIES WITH RESPECT TO THE AC-U-KWIK INFORMATION INCLUDED IN THIS DATA, EXPRESS OR IMPLIED, INCLUDING, BUT NOT LIMITED TO, THE IMPLIED WARRANTIES OF MERCHANTABILITY AND FITNESS FOR A PARTICULAR PURPOSE. THE INFORMATION IS PROVIDED "AS IS" AND AC-U-KWIK ORGANIZATIONS DO NOT WARRANT OR MAKE ANY REPRESENTATIONS REGARDING ITS ACCURACY, RELIABILITY, OR OTHERWISE. LICENSEE AGREES NOT TO SUE AC-U-KWIK ORGANIZATIONS AND, TO THE MAXIMUM EXTENT ALLOWED BY LAW, TO RELEASE AND HOLD HARMLESS AC-U-KWIK ORGANIZATIONS FROM ANY CAUSES OF ACTION, CLAIMS OR LOSSES RELATED TO ANY ACTUAL OR ALLEGED INACCURACIES IN THE INFORMATION ARISING OUT OF GARMIN'S USE OF THE INFORMATION IN THE DATASETS. SOME JURISDICTIONS DO NOT ALLOW THE LIMITATION OR EXCLUSION OF IMPLIED WARRANTIES OR LIABILITY FOR INCIDENTAL OR CONSEQUENTIAL DAMAGES SO THE ABOVE LIMITATIONS OR EXCLUSIONS MAY NOT APPLY TO LICENSEE.

WEATHER DATA WARRANTY

THE WEATHER DATA SOFTWARE PRODUCT IS PROVIDED "AS IS." ALL OTHER WARRANTIES, EXPRESSED OR IMPLIED, INCLUDING ANY WARRANTY OF MERCHANTABILITY OR FITNESS FOR A PARTICULAR PURPOSE OR OF NON-INFRINGEMENT ARE HEREBY EXCLUDED.

USER SAFETY

If you use SiriusXM Services it is your responsibility to exercise prudent discretion and observe all safety measures required by law and your own common sense. You assume the entire risk related to your use of the Services. SiriusXM and Garmin assume no responsibility for accidents resulting from or associated with use of the Services. Your Radio Service includes traffic and weather information, and you acknowledge that such information is not for "safety for life", but is merely supplemental and advisory in nature, and therefore cannot be relied upon as safety-critical in connection with any aircraft, sea craft or automobile usage. This information is provided "as is" and SiriusXM and Garmin disclaim any and all warranties, express and implied, with respect thereto or the transmission or reception thereof. SiriusXM and Garmin further do not warrant the accuracy, reliability, completeness or timeliness of the traffic and weather information disclosed on the Radio Service. In no event will SiriusXM and Garmin, their data suppliers, service providers, marketing/distribution, software or Internet partners or hardware manufacturers be liable to you or to any third party for any direct, indirect, incidental, consequential, special, exemplary or punitive damages or lost profits resulting from use of or interruptions in the transmission or reception of the Services.

LIMITS ON OUR RESPONSIBILITY

a) DISCLAIMERS.

EXCEPT AS EXPRESSLY PROVIDED HEREIN, WE MAKE NO WARRANTY OR REPRESENTATION, EITHER EXPRESS OR IMPLIED, REGARDING THE RADIO SERVICE. YOUR USE OF THE SERVICE IS AT YOUR SOLE RISK. THE CONTENT AND FUNCTIONALITY OF THE SERVICE IS PROVIDED "AS IS" WITHOUT ANY WARRANTY OF ANY KIND, EXPRESS OR IMPLIED. ALL SUCH WARRANTIES OR REPRESENTATIONS (INCLUDING, WITHOUT LIMITATION, THE IMPLIED WARRANTIES OF MERCHANTABILITY, FITNESS FOR A PARTICULAR PURPOSE, TITLE AND NON-INFRINGEMENT) ARE HEREBY DISCLAIMED.

b) LIMITATIONS OF LIABILITY.

WE ARE NOT RESPONSIBLE FOR ANY SPECIAL, INCIDENTAL, OR CONSEQUENTIAL DAMAGES OR LOSSES RELATING TO THE USE OF THE RADIO SERVICE, WHETHER BASED ON NEGLIGENCE OR OTHERWISE. OUR TOTAL LIABILITY TO YOU AND ANY OTHER PERSONS RECEIVING OUR SERVICES, REGARDLESS OF THE CAUSE, WILL IN NO EVENT EXCEED THE AMOUNTS THAT YOU HAVE PAID TO US FOR THE SERVICE THAT YOU RECEIVED DURING THE SIX (6) MONTH PERIOD IMMEDIATELY PRIOR TO THE SPECIFIC EVENT THAT GAVE RISE TO THE APPLICABLE DAMAGE OR LOSS. THIS ALLOCATION OF RISK IS REFLECTED IN OUR PRICES. YOU MAY HAVE GREATER RIGHTS THAN DESCRIBED ABOVE UNDER YOUR STATE'S LAWS

This product was developed using DAFIF™, a product of the National Geospatial-Intelligence Agency.

This product has not been endorsed or otherwise approved by the National Geospatial-Intelligence Agency, or the United States Department of Defense (10 U.S.C. 425)

- a. Under 10 U.S.C. 456, no civil action may be brought against the United States on the basis of the content of a navigational aid prepared or disseminated by either the former Defense Mapping Agency (DMA), National Imagery and Mapping Agency (NIMA), or the National Geospatial-Intelligence Agency (NGA).
- b. The DAFIF™ product is provided "as is," and no warranty, express or implied, including, but not limited to the implied warranties of merchantability and fitness for particular purpose or arising by statute or otherwise in law or from a course of dealing or usage in trade, is made by NGA as to the accuracy and functioning of the product.
- c. Neither NGA nor its personnel will be liable for any claims, losses, or damages arising from or connected with the use of this product. The user agrees to hold harmless the United States National Geospatial-Intelligence Agency. The user's sole and exclusive remedy is to stop using the DAFIF product.

SIRIUSXM SATELLITE RADIO SERVICE AGREEMENT

SiriusXM Satellite Radio Inc.

Hardware and required monthly subscription sold separately. Subscription fee is consumer only. Other fees and taxes, including a one-time activation fee may apply. All programming fees and weather data subject to change. SiriusXM Weather data displays and individual product availability vary by hardware equipment. Reception of the SiriusXM signal may vary depending on location. Subscriptions subject to Customer Agreement included with the SiriusXM Welcome Kit and available at siriusxm.com. Available only in the 48 contiguous United States. SiriusXM WX is a trademark of SiriusXM Satellite Radio Inc.

Contact SiriusXM Satellite Radio by phone at 800.985.9200 to subscribe to SiriusXM Weather and/or SiriusXM Radio.

FCC COMPLIANCE

This device complies with part 15 of the FCC Rules. Operation is subject to the following two conditions: (1) this device may not cause harmful interference, and (2) this device must accept any interference received, including interference that may cause undesired operation.

This equipment has been tested and found to comply with the limits for a Class B digital device, pursuant to part 15 of the FCC rules. These limits are designed to provide reasonable protection against harmful interference in a residential installation. This equipment generates, uses, and can radiate radio frequency energy and may cause harmful interference to radio communications if not installed and used in accordance with the instructions. However, there is no guarantee that interference will not occur in a particular installation. If this equipment does cause harmful interference to radio or television reception, which can be determined by turning the equipment off and on, the user is encouraged to try to correct the interference by one of the following measures:

- Reorient or relocate the receiving antenna.
- Increase the separation between the equipment and the receiver.
- Connect the equipment into an outlet that is on a different circuit from the GPS unit.
- Consult the dealer or an experienced radio/TV technician for help.

This product does not contain any user-serviceable parts. Repairs should only be made by an authorized Garmin service center. Unauthorized repairs or modifications could result in permanent damage to the equipment, and void your warranty and your authority to operate this device under Part 15 regulations.

INDUSTRY CANADA COMPLIANCE

Category II radio communication devices comply with Industry Canada Standard RSS-310.

Symbols

978 MHz 153
1090 MHz 153

A

AC-U-KWIK 180, 198, 199
ADS-B 153, 163
ADS-B In 153
ADS-B Out 153
ADS-B participating 153
ADS-R 154
Aircraft Profile 234
AIRMET 112, 133
Airport
 Criteria 33
Airspace 74
Airways 57
 Reviewing 58
alarms
 VNAV 43
antenna 219
AOPA 20, 64, 180, 198, 199, 256
Approach
 Loading 84, 97, 98, 99
Automatic Dependent Surveillance-
 Broadcast 153
Automatic Dependent Surveillance-
 Rebroadcast 154

B

Backlight 28
Battery 2
Bearing/distance, measuring 51

C

cable 207
cards, data 197

Chart Not Available 172, 176
ChartView 20, 48, 167, 169, 171, 172,
 173, 201
Compass Arc 38
connecting the power cable 198, 207
Controls 8
Course 42
course deviation indicator 41, 101
course deviation scale 40
Current Icing Product (CIP) 115

D

Data Bar Fields 36
Databases
 Updating 202
data card 197
Data entry 11–12
Data Logging 188
Date & Time 30
Delete
 Deleting Flight Records 227
 Flight plans 90, 92
 Individual waypoint 94
density altitude 233
Direct-to 76
Display 26
 Backlight Timeout 28

E

E6B 232
EPE Circle 237
EXPORT 23, 95, 205, 206, 230

F

FCC 258
FIS-B 154
FlightBook 225

Flight Information Service-Broadcast
154
flight log 225
FliteCharts 174, 176, 179
Expiration 179
Range 173
Fuel Flow 90

G
GBT 154
GDL 39 21, 124, 126, 148, 153, 163,
164

GPS Receiver Status 6
Ground Based Transceivers 154
GTX 330 213
GXM 40 antenna
connecting 210

H
Heading Line 230
Horizontal Situation Indicator (HSI)
252
HSI 40

I
Icing Forecast 115
IMPORT 23, 95, 205
Interface 31

J
Jeppesen database
updates 197

L
Legends 139
limited warranty 255
Loss of GPS 195

M

Map
Detail 54
Orientation 47
Panning 50
Range 48
Symbols 54
MAP Page
Defaults 139
Map Range 48
MapSource 197
Map Symbols 54
Measuring 51
Menus
Main Menu 10
Page Menu 10
METAR 132
Flag Color 133
Text 133

N

navigate
track 230
Navigation (NAV)
Map 35
Nearest
Airport 65
Airports 17, 35, 64, 67, 68, 69, 70,
72, 74
Airspaces 74, 75
NDB 68, 69
VORs 69
Nearest Information 64
NEXRAD 127, 128
NMEA 211, 212, 213

O

Obstacles 142

P

Pages

- FPL Pages 15
- Main Pages 15
- NRST Pages 15

Panning 50

PIREP 135

power 207

Proximity Waypoints 238

R

Reset 195

S

SafeTaxi 167, 169

SafeTaxi database 169

Satellite View 53

show/hide 65, 172

SIGMET 112, 134

SiriusXM

- Satellite Radio 188

- SiriusXM Radio 182

Softkeys 23

Sound 28

Supercooled Large Droplet (SLD) 116

Symbols 54

- Map 241

System

- Functionality 10

System ID 202

T

TAFs 132

Temperatures Aloft 131

Terrain 141

- Alerts 143, 146

TIS-A

- symbology 149

TIS-B 154

Topography 52

Track Log 227

 Traffic Information Service-Broadcast
154

 Traffic Information Service (TIS-A)
221–222

- Configuring 214, 217

traffic warning window 151, 160

true airspeed 233

Turbulence Forecast 115

U

UAT 154

Universal Access Transceiver 153

USB

- data cable 209

User Waypoints 70

Utilities 34

V

vectors 100

VNAV 44

W

Water Temperature 118

Waypoints 70

Weight & Balance 236

winds aloft 233

Winds Aloft 131

X

xImage 210

X symbol on terrain 142

Blank Page



Garmin International, Inc.
1200 East 151st Street
Olathe, KS 66062, U.S.A.
p: 913.397.8200
f: 913.397.8282

Garmin AT, Inc.
2345 Turner Road SE
Salem, OR 97302, U.S.A.
p: 503.391.3411
f: 503.364.2138

Garmin (Europe) Ltd
Liberty House, Bulls Copse Road
Hounslow Business Park
Southampton, SO40 9RB, U.K.
p: 44/0870.8501241
f: 44/0870.8501251

Garmin Corporation
No. 68, Jangshu 2nd Road
Shijr, Taipei County, Taiwan
p: 886/2.2642.9199
f: 886/2.2642.9099

www.garmin.com